



2024 / 2025

Original Equipment for the aftermarket

Spiegelsysteme für Nutzfahrzeuge
Mirror systems for commercial vehicles



Inhalt index

Aufbau der MEKRA Artikelnummern

Structure of the MEKRA article numbers 04

Verzeichnis der Spiegel-Typen

Mirror type list 05

Liste aller MEKRA Artikel im Katalog

List of all MEKRA-articles in this catalogue 06-07

Homologationsnummernliste

List of homologation numbers 08-09

Vergleichsliste nach OE - Nummern

Cross-reference-table 10-17

Fahrzeughersteller

Manufacturer 18-79

DAF 18-25

FORD 26-27

IVECO 28-29

MAN 30-47

MERCEDES 48-61

RENAULT 62-65

SCANIA 67

VOLVO 68-72

VOLKSWAGEN (VW) 73-77

UNIVERSAL 78-91

Allgemeine Verkaufs- und Lieferbedingungen

General terms and conditions of sale and delivery 92-93

9 stellig digit

04...	
08...	
09...	
10...	
11...	
13...	
14...	
15...	
20...	
39...	
40...	
51...	
53...	
55...	
56...	
58...	
59...	
61...	

3. - 5. Ziffer digit = Spiegeltyp mirror type

12 stellig digit

08...	
09...	
11...	
12...	
14...	
15...	
19...	
20...	
40...	
51...	
55...	
56...	
58...	
59...	
61...	

3. - 6. Ziffer digit = Spiegeltyp mirror type

z. B. / e. g. 59.5800.101H = Typ / type 580

59.2910.001.001 = Typ / type 291

59.1018.003.099 = Typ / type 1018



152 ASKB	80
224	72
248/2 A	89
249 K	57
249 L	57
250	68
251	32
252	68
253	48
254	48
260	30
265	31
266	31
266-1	31
270 A	91
271	44,85
271 A	89
276	44
277	46
278	45
279	29
281	56
289	80
291	86,87
300	79
320	30
340	30
341	30
348	19,64
349	57,73
349 TW	57,73
360	68
360-1	68
363	80
364	32
365-1	31
370	68
371	68
373	18,34
375	49
375 A	49
377	49,52



377-1	49,52
378	52
378 A	52
378-1	52
380-1	35
381-1	35
385	78
386	18,34
386-1	18
389	79
390	24,62,69
392	36
392-1	37
392-2	38
393-1	37
393-2	38
395	56
396	51,53
398	56
400	67
552	21
552-1	21,64,69,78,79
558	65
559	20,23
570	20
570 A	21
571	20
572	33,72
573	33,72
574	20
575	50
575 A	50
577	50
579	33,36,38,39,51,53
580	39
589	58,59,74,75
600	54
750	79
906	18
1000	25,63,70
1004	51,53,54
1005	21,23,67



1008	28,29
1009	81
1010	82
1012	54
1013	42,43,76,77
1016	90
1017	82
1018	84
1019	67
1020	41,67
1024	40
1025	21,65,72
1027	22
1033	62
1036	83
1038	82
1039	60,61
1041	47
1042	47
1043/1044	71
1049	26,27



04.0603.007.000	36,37,38	11.3921.110H	36,37	15.3774.410H	49,52	19.1049.003.099	27	40.3605.204F	68
08.1024.124.099	47,67,88	11.3921.120H	36,37	15.3780.840H	52	19.1049.004.099	26	40.3605.403H	68
08.1039.001.099	60	11.3921.400	37,38	15.3784.470H	52	19.1049.004.099	27	40.3640.222H	30,32
08.1039.002.099	60	11.3931.110H	37	15.3802.840H	35,80	19.1049.005.099	26	40.3640.322H	32
08.1039.005.099	60	11.3931.120H	37	15.3861.114H	18	19.1049.005.099	27	40.3640.422H	30,32
08.1039.006.099	60	11.5700.100H	20	15.3862.174H	18	19.1049.006.099	26	40.5725.212H	33
08.1039.011.099	60	11.5710.110H	20	15.3900.840H	24,64,69	19.1049.006.099	27	40.5725.412H	33,72
08.1049.001.099	26	11.5721.001.099	33,72	15.3910.871H	63	19.2790.011.099	29	40.5735.203H	33
08.1049.001.099	27	11.5731.001.099	33,72	15.3910.872H	63	19.2790.012.099	29	40.5735.403H	33,72
08.1049.002.099	26	11.5800.100H	39	15.3911.871H	24,62,69	19.2790.031.099	29	51.1009.001.099	81
08.1049.002.099	27	11.5800.200H	39	15.3911.871H	24,64,69	19.2790.032.099	29	51.1009.009.099	81
08.1049.003.099	26	11.9060.100H	18,23	15.3911.871H	64	19.2910.001.099	47,87	51.1009.017.099	81
08.1049.004.099	26	12.1005.001.099	23	15.3911.872H	24,62,69	19.2910.002.099	47,87	51.1009.021.099	81
08.2770.001.000	46	12.1018.001.099	84	15.3911.872H	24,64,69	19.3920.011.099	38	51.1009.022.099	81
08.2910.001.002	46,87	12.1018.002.099	84	15.3911.872H	64	19.3930.311.099	38	51.1009.025.099	81
08.3200.233H	45,46,84,87,88	12.1018.003.099	84	15.3920.840H	37	19.5740.311.099	20	51.1009.027.099	81
08.3950.001.099	46,87	12.1018.005.099	84	15.3921.870H	36	19.5750.011.099	50	51.1009.045.001	81
08.5380.004.000	72	12.1018.007.099	84	15.3922.870H	36	19.5770.311.099	50	51.1009.047.001	81
08.5752.012	45	12.1018.009.001	84	15.3932.870H	37	19.5890.011.099	59,61,75	51.1009.049.099	81
08.5752.024.099	24,64,69	12.1018.010.001	84	15.3946.670F	31	19.5890.012.099	59,61,75	51.1009.081.099	81
08.5752.024.099	45,46,62,63,69	12.1020.003.099	41,67	15.3951.114	56	19.5891.011.099	59,75	51.1009.097.099	81
		12.1024.009.099	40	15.3951.174	56	19.5891.012.099	59,75	51.1009.113.099	81
08.5890.300.099	59,75	12.1024.010.099	40	15.3961.174H	51,53	20.1000.611.199	25,63,70	51.1009.121.099	81
08.5890.301.099	59,75	12.1024.011.099	40	15.4001.740H	67	20.1000.612.199	25,63,70	51.1009.122.099	81
08.5892.001.099	59,75	12.1024.012.099	40	15.4001.840H	67	20.1000.613.199	25,63,70	51.1009.149.099	81
08.5892.002.099	59,61,75	12.1027.001.099	22	15.5701.840H	20	20.1000.614.199	25,63,70	51.1009.242.099	81
08.5892.003.099	59,61,75	12.1027.002.099	22	15.5711.870H	20	20.1016.004.000	90	51.1010.010.001	82
08.5892.004.099	59,75	12.1027.005.099	22	15.5750.840H	50	20.1042.002.099	47	51.1036.007.099	83
08.5892.105.099	59,61,75	12.1027.006.099	22	15.5770.870H	50	20.1042.003.099	47	51.1036.008.099	83
09.1000.200.099	71	12.1027.015.099	22	15.5791.470H	33,36,51,53	20.2480.210H	89	51.1036.009.099	83
09.1000.400.199	25,63,70	12.1027.016.099	22	15.5791.570.099	33,36,38,39	20.2480.211H	89	51.1036.010.099	83
09.1041.002.099	47	12.1027.103.099	22	15.5801.840H	39	20.2480.213	85,89	51.1036.021.099	83
09.1041.004.099	47	12.1027.104.099	22	15.5811.871H	39	20.2480.216H	44,56,85,89	51.1036.022.099	83
09.2000.301H	30,31,78,81,88	12.1027.107.099	22	15.5811.872H	39	20.2480.217H	44,56,85,89	51.1036.023.099	83
09.2070.101H	30,32,48,68,88	12.1027.108.099	22	15.5891.611H	59,75	20.2480.223	89	51.1036.024.099	83
09.2770.001.000	46,87	12.1027.203.099	22	15.5891.612H	59,75	20.2700.200H	44,85	51.1036.025.099	83
09.2770.210	46	12.1027.204.099	22	15.5891.721.099	59,61,75	20.2710.111H	85	51.1036.026.099	83
09.2770.211	46	12.1027.207.099	22	15.5891.722.099	59,61,75	20.2710.121	85	51.1038.003.099	82
09.2910.002.099	84,87	12.1027.208.099	22	15.5891.741H	59,75	20.2710.200H	44,85	51.1038.004.099	82
09.2910.003.099	46,87	12.1041.001.099	47	15.5891.742H	59,75	20.2710.620	44,45,89	51.1043.001.099	71
09.2910.004.099	87	12.1041.002.099	47	15.6000.001.099	54	20.2710.650	45	51.1043.002.099	71
09.2910.005.099	84,87	12.1041.003.099	47	15.6000.002.099	54	20.3750.710.099	49	51.1044.001.099	71
09.2910.007.000	87	12.1041.004.099	47	15.6000.003.099	54	20.3750.720.099	49	51.1044.002.099	71
09.3200.220	88	12.1041.005.099	47	15.6000.004.099	54	20.3780.700H	52	51.1524.119H	80
09.3200.320H	88	12.1042.001.099	47	15.9060.870H	18	20.3900.510H	24,62,63,69	51.2491.121H	57
09.3200.420H	30,81,83,88	12.1042.002.099	47	19.1000.101.099	71	20.3900.510H	24,64,69	51.2491.122H	57
09.3300.421	88	12.1049.001.099	26	19.1000.102.099	71	20.3900.520H	24,62,63,69	51.2493.121H	57
09.3400.420	30,78,88	12.1049.001.099	27	19.1000.103.099	71	20.3900.520H	24,64,69	51.2493.127H	57
09.3900.003.000	62,63,69	12.1049.002.099	26	19.1000.121.099	71	20.5521.100H	20	51.2500.127H	68
09.5700.001.099	20	12.1049.002.099	27	19.1000.122.099	71	20.5700.410H	21	51.2500.147H	68
09.5700.002.099	20	12.3920.001.099	38	19.1000.601.199	25,63,70	20.5700.420H	21	51.2510.127H	32
09.5750.001.099	50	12.3920.002.099	38	19.1000.602.199	25,63,70	20.5750.710.099	50	51.2510.137H	32
09.5750.220.099	50	12.3930.001.099	38	19.1000.603.199	25,63,70	20.5750.720.099	50	51.2510.147H	32
11.1008.001.099	28	12.3930.002.099	38	19.1008.041.099	28	20.5800.410H	39	51.2520.127H	68
11.1036.011.099	83	12.5590.009.099	23	19.1008.311.099	28	20.5800.420H	39	51.2520.147H	68
11.1036.012.099	83	12.5700.001.099	21	19.1012.000.099	54	20.5800.610H	39	51.2530.120H	48
11.1036.013.099	83	12.5700.002.099	21	19.1012.001.099	54	20.5800.620H	39	51.2530.140H	48
11.1036.014.099	83	12.5700.003.099	21	19.1012.002.099	54	20.5800.710H	39	51.2540.120H	48
11.1039.001.099	60	12.5700.004.099	21	19.1012.003.099	54	20.5800.720H	39	51.2540.130H	48
11.1039.002.099	60	12.5740.002.099	20	19.1013.011.099	43,77	20.5800.750H	39	51.2540.140H	48
11.1039.011.099	60	13.1000.601.199	25,63,70	19.1013.012.099	43,77	20.7504.003.001	79	51.2890.117H	80
11.1039.012.099	60	13.1000.602.199	25,63,70	19.1018.311.099	84	20.7504.044.001	79	51.2890.147H	80
11.2770.102	46	13.1000.603.199	25,63,70	19.1018.312.099	84	40.1009.001.000	81	51.3000.002.001	79
11.2770.202	46	13.1024.001.099	40	19.1019.013.099	67	40.1009.001.099	81	51.3000.003.001	79
11.2770.302	46	13.1024.002.099	40	19.1019.014.099	67	40.1009.002.000	81	51.3200.147H	30
11.2770.402	46	13.1024.003.099	40	19.1019.313.099	67	40.1009.002.099	81	51.3400.147H	30
11.2770.920	46	13.1024.004.099	40	19.1019.314.099	67	40.1009.003.099	81	51.3410.127H	30
11.2780.910	45	13.1039.001.099	60	19.1020.213.099	41,67	40.1009.004.099	81	51.3410.140	30
11.2780.920	45	13.1039.002.099	60	19.1020.613.099	41,67	40.1009.005.099	81	51.3410.147H	30
11.2790.001.099	29	13.1043.001.000	71	19.1024.011.099	40	40.1009.421.002	81	51.3412.120H	30
11.2790.002.099	29	13.1044.001.000	71	19.1024.012.099	40	40.1009.422.002	81	51.3490.110H	57
11.2810.200H	56	13.5800.100H	39	19.1024.311.099	40	40.1010.002.099	82	51.3490.112H	57
11.2910.001.000	87	13.5890.110.199	59,61,75	19.1024.312.099	40	40.1038.411.099	82	51.3490.120H	57
11.2910.002.000	87	13.5890.120.099	59,61,75	19.1027.011.099	22	40.1038.412.099	82	51.3490.122H	57
11.2910.003.000	87	13.5890.210.199	59,61,75	19.1027.012.099	22	40.1038.751.099	82	51.3495.112H	73
11.2910.004.000	87	13.5890.220.099	59,61,75	19.1027.311.099	22	40.1038.752.099	82	51.3635.201	80
11.2910.006.000	87	14.5890.100.099	59,61,75	19.1027.312.099	22	40.1525.114H	80	51.3635.204	80
11.2910.007.000	87	14.5890.200.099	59,61,75	19.1033.001.199	62	40.2500.222H	68	51.3635.206	80
11.2910.008.000	87	15.2240.840H	72	19.1033.002.199	62	40.2500.422H	68	51.3636.201	80
11.2910.009.000	87	15.2711.114	44,85	19.1036.005.099	83	40.2510.222H	32	51.3636.204	80
11.2910.011.002	87	15.2711.214H	57,73	19.1036.006.099	83	40.2510.322H	32	51.3636.206	80
11.2910.012.002	87	15.2712.113F	85	19.1036.007.099	83	40.2510.422H	32	51.3640.127H	32
11.3480.100	19,64	15.2712.114	44,85	19.1036.008.099	83	40.2520.222H	68	51.3640.137H	32
11.3730.210H	18,44,80,85	15.2771.840	46	19.1036.009.099	83	40.2520.422H	68	51.3640.147H	32
11.3730.310H	34	15.2771.870	46	19.1036.010.099	83	40.2530.222H	48	51.3731.325	34
11.3800.300H	35	15.278							

MEKRA-catalogue articles MEKRA-Katalog-Artikel



51.3850.167H	78	56.3812.128H	35	59.1000.642.199	25,63,70	59.1042.005.099	47	59.5800.121H	39
51.3850.197H	78	56.3812.148H	35	59.1005.001.099	21	59.1049.001.099	26	59.5800.122H	39
51.3850.227	78	56.3812.168H	35	59.1005.002.099	21	59.1049.001.099	26	59.5800.201H	39
51.3850.247	78	56.3860.112H	34	59.1005.003.099	67	59.1049.002.099	26	59.5800.202H	39
51.3850.267	78	56.3860.114H	34	59.1005.011.099	23	59.1049.003.099	26	59.5800.203H	39
51.3894.140H	79	56.3861.116H	34	59.1008.005.099	28	59.1049.004.099	26	59.5800.221H	39
51.3920.001.099	38	56.3862.116H	38	59.1008.006.099	28	59.1049.005.099	26	59.5800.222H	39
51.3920.002.099	38	56.3930.001.099	34	59.1008.011.099	28	59.1049.006.099	26	59.5800.223H	39
51.3920.003.099	38	56.3930.002.099	38	59.1008.012.099	28	59.1049.007.099	26	59.5800.302H	39
51.3920.004.099	38	56.3930.003.099	38	59.1008.017.099	28	59.1049.008.099	26	59.5800.322H	39
51.3920.005.099	38	56.3930.004.099	38	59.1008.018.099	28	59.1049.009.099	26	59.5800.402H	39
51.3920.012.099	38	56.3931.323H	37	59.1008.045H	28	59.1049.010.099	26	59.5800.422H	39
51.3920.013.099	38	56.3931.343H	37	59.1008.046H	28	59.1049.011.099	27	61.1000.004.099	71
51.3920.014.099	38	56.3932.323H	37	59.1008.051H	28	59.1049.012.099	27	61.1000.006.199	25,63,70
51.3921.222H	36	56.3932.343H	37	59.1008.052H	28	59.1049.013.099	27	61.1000.007.199	25,63,70
51.3921.223H	37	56.3960.148H	51,53	59.1008.057H	28	59.1049.014.099	27	61.1000.105.199	25,63,70
51.3921.224H	37	56.5730.120H	33	59.1008.058H	28	59.2652.110H	31	61.1009.001.099	81
51.3922.222H	36	56.5730.140H	33	59.1013.101.199	42,76	59.2710.401H	85	61.1009.002.099	81
51.3922.223H	37	56.5790.002.099	38,39	59.1013.102.199	42,76	59.2710.402H	85	61.1024.224.099	81
51.3922.224H	37	56.5790.003.099	33,36	59.1013.106.199	42,76	59.2710.406	85	61.1029.224.099	22
51.3923.223D	37	56.5790.004.099	33,36,51,53	59.1013.109.199	42,76	59.2710.454	85	61.1039.002.099	60
51.3923.224H	37	56.9065.110	18	59.1013.116.199	42,76	59.2712.111	44	61.1042.005.099	47
51.3924.223D	37	58.1000.611.199	25,63,70	59.1013.117.199	42,76	59.2712.114	44	61.1042.006.099	47
51.3924.224H	37	58.1000.612.199	25,63,70	59.1013.201.199	42,76	59.2762.101	44	61.2530.110H	48
51.5524.930H	64,69,79	58.1000.613.199	25,63,70	59.1013.202.199	42,76	59.2762.322	44	61.2703.110	91
51.5720.120H	33	58.1000.614.199	25,63,70	59.1013.212.199	42,76	59.2762.422	44	61.2703.120	91
51.5720.140H	33	58.1000.621.199	25,63,70	59.1013.216.199	42,76	59.2770.210.099	46	61.2708.842H	91
51.5721.160H	33	58.1000.622.199	25,63,70	59.1013.301.199	42,76	59.2770.211.099	46	61.2770.210	46
51.5722.160H	33	58.1000.623.199	25,63,70	59.1013.309.199	42,76	59.2770.310.099	46	61.2770.211	46
51.5750.001.099	50	58.1000.624.199	25,63,70	59.1013.316.199	42,76	59.2771.210.099	46	61.2770.900.099	46
51.5750.002.099	50	58.1000.641.199	25,63,70	59.1013.317.199	42,76	59.2780.120.099	45	61.2770.901.099	46
51.5750.003.099	50	58.1000.642.199	25,63,70	59.1013.401.199	42,76	59.2780.140.001	45	61.2772.100	46
51.5750.004.099	50	58.1016.001.099	90	59.1013.412.199	42,76	59.2780.150.001	45	61.2772.211.099	46
51.5770.001.099	50	58.1016.002.099	90	59.1013.416.199	42,76	59.2780.170.001	45	61.2910.001.001	87
51.5891.111.199	58,74	58.1016.003.099	90	59.1013.501.199	42,76	59.2780.180.001	45	61.2910.002.001	87
51.5891.112.199	58,74	58.1016.004.099	90	59.1013.509.199	42,76	59.2780.200.001	45	61.2910.003.001	87
51.5891.113.199	58,74	58.1016.005.099	90	59.1013.601.199	42,76	59.2781.120	45	61.2910.004.001	87
51.5891.114.199	58,74	58.1016.006.099	90	59.1013.612.199	42,76	59.2810.111H	56	61.2910.005.001	87
51.5891.211.199	58,74	58.1017.005.099	82	59.1018.001.099	84	59.2810.113H	56	61.2910.006.001	87
51.5891.212.199	58,74	58.1017.006.099	82	59.1018.002.099	84	59.2910.001.001	86	61.2910.007.001	87
51.5891.213.199	58,74	58.1017.011.099	82	59.1018.003.099	84	59.2910.002.001	86	61.2910.008.001	87
51.5891.214.199	58,74	58.1017.012.099	82	59.1018.004.099	84	59.2910.003.001	86	61.2910.021.001	87
51.5891.311.199	58,74	58.1017.013.099	82	59.1018.007.099	84	59.2910.004.001	86	61.2910.022.001	87
51.5891.312.199	58,74	58.1017.014.099	82	59.1018.008.099	84	59.2910.005.001	86	61.3000.003.010	79
51.5891.313.199	58,74	58.1017.015.099	82	59.1024.001.099	40	59.2910.006.001	86	61.3000.004.010	79
51.5891.314.199	58,74	58.1017.016.099	82	59.1024.002.099	40	59.2910.007.001	86	61.3480.149H	19,64
51.5891.411.199	74	58.1038.003.099	82	59.1024.005.099	40	59.2910.008.001	86	61.3481.149H	19,64
51.5891.412.199	58,74	58.1038.004.099	82	59.1024.006.099	40	59.2910.009.001	86	61.3482.149H	19,64
51.5891.413.199	58,74	58.2704.044	91	59.1024.009.099	40	59.2910.010.001	86	61.3730.324H	18
51.5891.414.199	58,74	58.2704.048	91	59.1024.010.099	40	59.2910.013.001	86	61.3730.326H	18
51.5892.111.199	58,74	58.2704.051H	91	59.1024.013.099	40	59.2910.014.001	86	61.3752.147H	49,56
51.5892.112.199	58,74	58.2704.070	91	59.1024.014.099	40	59.2910.015.001	86	61.3752.167H	49,56
51.5892.113.199	58,74	58.2704.086	91	59.1024.017.099	40	59.2910.016.001	86	61.3770.147H	49,52
51.5892.211.199	58,74	58.2704.088	91	59.1024.019.099	40	59.2910.017.001	86	61.3772.147H	49,52
51.5892.212.199	58,74	58.2704.093	91	59.1024.021.099	40	59.2910.018.001	86	61.3773.147H	49,52,56
51.5892.213.199	58,74	58.2705.001H	91	59.1024.022.099	40	59.2910.019.001	86	61.3780.100H	49,51,52,53,56
51.5892.311.199	58,74	58.2705.003	91	59.1024.023.099	40	59.2910.020.001	86	61.3782.147H	52
51.5892.312.199	58,74	58.3752.100	49	59.1024.024.099	40	59.3491.110H	57	61.3782.167H	52
51.5892.313.199	58,74	58.3752.200	49	59.1024.025.099	40	59.3491.120H	57	61.3783.147H	52
51.5892.411.199	58,74	58.3781.100H	52	59.1024.026.099	40	59.3492.110H	57	61.3783.167H	52
51.5892.413.199	58,74	58.3781.200H	52	59.1024.027.099	40	59.3492.120H	57	61.3860.100	18
51.5893.111.199	58,74	58.3783.200H	52	59.1024.028.099	40	59.3601.128H	68	61.3860.214H	18
51.5893.112.199	58,74	58.3783.300H	52	59.1024.029.099	40	59.3601.178H	68	61.3865.124H	18
51.5893.113.199	58,74	58.3900.133H	24	59.1024.030.099	40	59.3601.188H	68	61.3900.100H	24,62,63,69
51.5893.211.199	58,74	58.3900.133H	24,64,69	59.1025.001.099	21,65,72	59.3602.128H	68	61.3900.100H	24,64,69
51.5893.212.199	58,74	58.3900.143H	24	59.1025.002.099	21,65,72	59.3652.128H	31	61.3900.110H	24,62,63,69
51.5893.213.199	58,74	58.3900.143H	24,64,69	59.1027.001.099	22	59.3652.148H	31	61.3900.110H	24,64,69
51.5894.112.199	58,74	58.3900.233H	24	59.1027.002.099	22	59.3652.168H	31	61.3900.120H	24,62
51.5894.212.199	58,74	58.3900.233H	24,64,69	59.1027.003.099	22	59.3891.140H	79	61.3900.130H	24,62,63,69
51.5894.310.199	58,74	58.3900.243H	24	59.1027.004.099	22	59.3900.123H	--	61.3900.130H	24,64,69
51.5894.410.199	58,74	58.3900.243H	24,64,69	59.1039.101.099	60	59.3962.210H	51	61.3902.110H	24
51.5895.312.199	58,74	58.3900.333H	24	59.1039.105.099	60	59.3964.210H	51	61.3902.120H	24
51.5895.412.199	58,74	58.3900.333H	24,64,69	59.1039.125.099	60	59.3965.210H	53	61.3910.110H	62
51.7504.044.001	79	58.3900.433H	24	59.1039.151.099	60	59.3980.011H	56	61.3910.120H	62
55.1008.002.099	29	58.3900.433H	24,64,69	59.1039.155.099	60	59.3980.012	56	61.3911.110H	24,62,69
55.1008.003.099	29	58.5700.001.099	21	59.1039.158.099	60	59.3980.021H	56	61.3911.120H	24,62,69
55.1008.004.099	29	58.5700.003.099	21	59.1039.175.099	60	59.3980.022H	56	61.3911.120H	24,64,69
55.3000.002.001	79	58.5700.004.099	21	59.1039.201.099	60	59.3980.111	56	61.3911.110H	24,64,69
55.3000.004.001	79	58.5701.104.099	21	59.1039.205.099	60	59.3980.121	--	61.3913.110H	24
55.3000.005.001	79	58.5710.001.099	21	59.1039.225.099	60	59.3980.122	56	61.3913.120H	24
56.1004.001.099	51,53,54	58.5713.114.099	21	59.1039.251.099	60	59.3980.132	56	61.5590.001.099	20,87
56.1008.002.099	28	58.5750.005.199	50	59.1039.255.099	60	59.3980.141	56	61.5700.210H	20
56.1008.003.099	28	58.5750.012.199	50	59.1039.258.099	60	59.3980.142	56	61.5700.310.099	20
56.1008.004.099	28	58.5752.100H	50	59.1039.275.099	60	59.5520.130H	21	61.5710.210H	20
56.1020.015.099	41	58.5752.200H	50	59.1039.501.099	61	59.5520.230H	21	61.5710.310.099	20
56.1020.017.099	41	58.5752.300H	50	59.1039.551.099	61	59.			

Homologationsnummern List of homologation numbers

e	E	Typ · type tipo · тип	Tip	
II	e1	03*0002	575	50
IV	e1	03*0003	577	50
V	e5	02*0003	156/6 BO	--
IV	e11	03*0003	224	72
IV	E11	02*0003	224	72
V	e5	02*0004	156/6 BO	--
V	e11	03*0004	224	72
VI	e11	03*0005	224	72
VI	E11	02*0005	224	72
III	e1	03*0006	589	58,59,74,75
III	e1	03*0007	570	20
IV	e1	03*0008	571	20
II	e1	03*0009	390	62,63,69
IV	e1	03*0010	390	62,63,69
V	e1	03*0011	558	65
V	e1	02*0013	379-1	--
IV	e1	03*0014	906	18
VVI	e1	03*0015	365-1	31
			394, 394-1	--
VI	e1	03*0016	389	79
VI	e1	03*0017	396	51,53
II	e1	03*0018	378-1	52
IV	e1	02*0019	377-1	49,52
II	e1	03*0022	271	44,85
			271-K	--
			276	44
			363	80
			373	18,34
			380-1	35
IV	e1	03*0023	386, 386-1	--
			381-1	35
II	e1	03*0024	392-1	37
II	e1	03*0024	392-2	38
IV	e1	03*0025	393-1	37
IV	e1	03*0025	393-2	38
II	e1	03*0031	572	33,72
IV	e1	03*0032	573	33,72
V+VI	e1	03*0033	552-1	21,64,69,78,79
V+VI	e1	03*0037	390	62,63,69
V	e1	02*0039	360-1	68
VI	e1	03*0042	287-1 / 288-1	--
V	e1	03*0044	287-1 / 288-1	--
II	e1	03*0047	273	--
			395	56
II	e1	03*0048	340	30
II	e11	03*0050	400	67
II	E11	02*0050	400	67
IV	e11	03*0051	400	67
IV	E11	02*0051	400	67
II	e1	03*0060	364-1	--
II	E1	01*00620	273	--
			395	56
II	e1	03*0082	274	--
II	e1	03*0084	277	46
II	e1	03*0088	271	44,85
			271-K	--
			276	44
			363	80
			373	18,34
			380-1	35
II	e1	03*0097	580	39
IV	e1	03*0098	580	39
V	e1	03*0109	579	--
			33,36,38,39,51,53	--
II	e1	03*0115	380-1	35
II	e1	03*0123	375	49
			398	56
II	e1	03*0124	281	56
II	e1	03*0128	278	45
IV	e1	03*0129	278	45
V	e1	03*0174	395	56
II	e1	03*0184	348	19,65
V	e1	03*0185	348	19,65
II	e1	03*0188	374-1	--
IV	E5	01*019	156/6 BO	--
VI	e1	03*0196	559	21,23
V	E5	01*020	156/6 BO	--
IV	e1	03*0234	371-1	71
II	e1	03*0242	1000-1	71
IV	e1	03*0243	1000-2	71
V	e1	03*0244	1001	--
VI	e1	03*0245	1002	--
II	e1	03*0257	385-1	--
II	E1	01*0376	258	--
II	E1	01*0377	258	--
II	e1	02*0382	385	78
II	e1	02*0384	349	57,73
II	E1	01*0384	349	57,73
II	e1	01*0391	282	--
II	e1	01*0392	283	--
IV	E1	01*0392	283	--
IV	e1	01*0394	367	--
IV	E1	01*0394	367	--
II	e1	01*0395	368	--
II	e1	02*0418	349	57,73
II	e1	01*0423	271	44,85
			276	44

e	E	Typ · type tipo · тип	Tip	
			363	80
			373	18,34
			380-1	35
II	E1	01*0423	271	44,85
			276	44
			363	80
			373	18,34
			380-1	35
IV	e1	02*0424	386, 386-1	--
			381, 386-1	--
IV	E1	01*0424	386, 386-1	--
			381	--
II	e1	02*0447	281	56
II	E1	01*0447	281	56
IV	e1	02*0448	281	56
II	E1	01*0448	281	56
IV	e1	02*0462	377	49,52
IV	E1	01*0462	377	49,52
II	e1	02*0463	378	52
II	E1	01*0463	378	52
V	e1	02*0464	379	--
V	E1	01*0464	379	--
II	e1	01*0469	385	78
II	E1	01*0469	385	78
II	e1	02*0487	372	--
IV	e1	02*0488	372	--
II	e1	02*0505	375	49
			398	56
II	E1	01*0505	375	49
			398	56
II	e1	02*0524	271	44,85
			276	44
			363	80
			373	18,34
			380-1	35
II	E1	01*0524	271	44,85
			276	44
			363	80
			373	18,34
			380-1	35
II	e1	02*0529	380-1	35
III	e1	02*0569	198	--
III	E1	01*0569	198	--
II	e1	02*0620	273	--
			395	56
II	e1	02*0646	392	36
II	E1	01*0646	392	36
V	e1	02*0647	284	--
IV	E1	01*0647	393	36
II	e1	02*0662	374 (LDV)	--
II	e1	02*0688	405	--
IV	e1	02*0689	406	--
II	e1	02*0740	550	--
IV	e1	02*0741	551	--
V	e1	02*0742	552	21
V	E1	01*0742	552	21
II	e1	01*0798	901 (Iveco)	--
VVI	E1	02*0894	552-1	21,64,69,78,79
III	E1	02*0902	589	58,59,74,75
VI	E1	02*0902	1039	61
III	E1	02*0902	1039	61
II	E1	02*0905	271	44,85
			276	44
			363	80
			373	18,34
			380-1	35
IV	E1	02*0906	906	18
II	E1	02*0910	274	--
V	E1	02*0912	558	65
IV	E1	02*0913	390	62,63,69
II	E1	02*0914	390	62,63,69
II	E1	02*0915	227	--
IV	E1	02*0916	390	62,63,69
IV	E1	02*0917	573	33,72
II	E1	02*0918	572	33,72
VVI	E1	02*0922	365-1	31
			394, 394-1	--
II	E1	02*0923	271	44,85
			276	44
			363	80
			373	18,34
			380-1	35
IV	E1	02*0924	393-1	37
IV	E1	02*0924	393-2	38
II	E1	02*0925	392-1	37
II	E1	02*0925	392-2	38
II	E1	02*0926	273	--
			395	56
II	E1	02*0929	580	39
IV	E1	02*0930	580	39
VI	E1	02*0937	389	79
II	E1	02*0939	380-1	35
II	E1	02*0941	375	49
			398	56
II	E1	02*0942	281	56
II	E1	02*0951	278	45

e	E	Typ · type tipo · тип	Tip	
IV	E1	02*0952	278	45
V	E1	02*0973	360-1	68
V	E1	02*0998	395	56
V	e1	*10025	156/4 BO	--
I	e1	02*10041	202	--
II	e1	*10042	152 AS	--
III	E1	02*1020	922, 923	--
V	e3	03*1021	463-1	--
V	E3	01*1021	463-1	--
III	E1	02*1021	922, 923	--
IV	e3	03*1022	462	--
IV	E3	01*1022	462	--
IV	E1	02*1023	348	19,65
V	e3	03*1031	1008	28,29
II	e3	03*1034	1008	28,29
IV	e1	02*1035	349 TW	57,73
IV	e3	03*1036	1008	28,29
VI	E1	02*1039	559	21,23
VI	e3	03*1042	1008	28,29
II	e9	01*1047	271	44,85
			276	44
			373	18,34
IV	e9	01*1054	386	18,34
II	e9	01*1063	460	--
II	e9	01*1073	271	44,85
			276	44
			373	18,34
IV	e9	01*1074	386	18,34
V	e9	01*1075	463-1	--
IV	e1	02*11001	260	30
II	e1	*11002	156/6 BO	--
IV	e1	02*11003	283	--
IV	e1	*11004	266	31
IV	e1	02*11005	268	--
IV	e1	*11006	267	--
IV	e1	02*11007	266	31
IVV	E1	02*11008	266, 266-1	--
IVV	E1	01*11008	266, 266-1	--
IVV	E1	02*11008	266, 266-1	--
IV	e1	02*11009	266	31
IV	e1	02*11010	462	--
IV	E1	01*11010	462	--
IV	e1	02*11011	367	--
IV	E1	01*11011	367	--
IV	e1	02*11012	285	--
IV	E1	01*11012	285	--
IV	e1	02*11013	268	--
IV	e1	02*11014	267	--
IV	e1	*11015	266	31
IV	e1	02*11016	371	68
IV	E1	01*11016	371	68
II	e4	02*1104	110	--
II	E4	01*1104	110	--
II	e4	01*1106	257	--
II	E1	02*1108	1000	25,63,70,71
IV	E1	02*1109	1000	25,63,70,71
II	E1	02*1112	600	54
IV	E1	02*1113	600	54
VI	E1	02*1114	603	--
II	E1	02*1144	575	50
IV	E1	02*1145	577	50
II	e6	01*116	250	68
II	E1	02*1165	1009 / 1017	--
V	e9	04*11687	279	29
V	e9	04*11688	279	29
V	E1	02*1178	1014	--
V	E1	02*1178	1004	51,53,54
V	E1	02*1179	579	--
			33,36,38,39,51,53	--
IV	e9	04*11853	279	29
II	e9	04*11854	279	29
V	e1	02*12001	156/5 BO	--
V	e1	*12002	156/2 BO	--
V	e1	02*12003	284	--
V	E1	01*12003	284	--
V	e1	*12004	156/6 BO	--
V	e1	*12005	265	31
V	e1	02*12006	265	31
V	e1	02*12007	265	31
V	E1	01*12007	265	31
V	e1	02*12008	265	31
V	e1	02*12009	463-1	--
V	E1	01*12009	463-1	--
II	e4	02*12011/1202	253	48
II	e4	02*12011/1202	254	48
II	e4	02*12011/1202	258	--
V	e1	02*12010	269	--
V	E1	01*12010	269	

List of homologation numbers Homologationsnummern

e	E	Typ · type tipo · тип	Tip	
II	e1	01*14068	254	48
II	e1	01*14069	258	--
II	E1	01*14069	258	--
II	e1	01*14070	254	--
II	e1	01*14071	255	--
			256	--
II	e1	02*14072	258	--
II	e1	02*14073	40.4495.222	--
			253	48
II	e1	01*14075	251	32
II	e1	02*14076	152 AS	--
II	e2	02*14080	364	32
II	e1	02*14082	364	32
II	E1	01*14082	364	32
II	e1	02*14083	282	--
II	E1	01*14083	282	--
II	e1	02*14084	282	--
II	e1	*14085	340 / 341	--
II	e1	*14086	253	48
II	e1	02*14087	340 / 341	--
II	e1	02*14088	249 L	--
II	e1	02*14089	252	68
II	E1	01*14089	252	68
II	e1	02*14090	251	32
II	e1	*14091	253	48
II	e1	02*14092	254	48
II	e1	*14093	253	48
II	e1	*14094	253	48
II	e1	01*14095	254	48
II	e1	01*14096	253	48
II	e1	02*14097	258	--
II	E1	01*14097	258	--
II	e1	02*14098	340 / 341	--
II	E1	01*14098	340 / 341	--
II	e1	02*14099	254	48
II	e1	02*14100	330 / 331	--
II	E1	01*14100	330 / 331	--
II	e1	02*14101	340 / 341	--
II	e1	02*14102	460	--
II	E1	01*14102	460	--
II	e1	02*14103	461	--
II	E1	01*14103	461	--
II	e1	02*14105	368	--
II	e1	02*14108	254	48
II	e1	02*14109	254	48
II	e1	02*14111	385	--
II	e1	02*14112	258	--
II	e1	02*14117	280	--
II	E1	01*14117	280	--
II	e1	01*14119	249 L	--
II	e1	02*14121	366	--
II	e1	02*14122	364/1	--
II	e1	02*14123	368	--
II	E1	01*14123	368	--
II	e1	01*14124	340 / 341	--
II	e1	02*14125	370	68
II	E1	01*14125	370	68
II	e1	02*14126	371	68
II	E1	01*14126	371	68
II	e1	02*14142	364	32
II	E13	02*1456	38.3730.210H	--
IV	e13	03*1457	906	18
II	E1	041459	1036	83
II	E1	041469	1039	60
II	E1	041480	1041	47
II	E1	041481	1041	47
IV	E1	041482	1041	47
IV	E1	041540	1000	71
II	E1	041541	1000	71
IV	E1	041542	1024	40
II	E1	041543	1024	40
IV	e1	02*1550	264	--
V	e1	02*1551	264	--
II	e13	02*1558	253	48
II	E1	041619	1027	22
IV	E1	041620	1027	22
IV	E1	041620	1027	22
IV	E1	051696	1038	82
III	e1	01*17023	249 A	--
			249 K	57
II	e1	*17087	151 K	--
III	e1	01*17098	249 A	--
			249 K	57
II	e1	*17105	156/4 BO	--
II	e1	*17140	149 K	--
II	e1	01*17149	198	--
II	e1	01*17194	200 (Ford)	--
III	e1	02*17324	196	--
III	e1	02*17335	249 L	57
II		*18792	572	33,72
II	e4	01*2067	254	48
II	e4	02*2069	259	--
II	E4	01*2069	259	--
II	E6	00*208	250	68
II	e4	01*2083	252	68
II	e1	03*0242	1000	71
IV	e1	03*0243	1000	71

e	E	Typ · type tipo · тип	Tip	
II	e1	*2407	244 A	--
II	e4	03*2563	373	18,34
II	E4	02*2563	373	18,34
II	e1	*2901	156/6 BO	--
II	e3	*30011	472	--
II	e3	*30595	467	--
II	e2	01*307	291	86,87
II	e3	*32806	467	--
II	e3	*32906	472	--
II	e3	*32908	474 (Iveco)	--
II	e3	*33488	473 (Iveco)	--
II	e3	*33491	472	--
II	e3	*34767	472	--
II	e3	*35216	472	--
II	e3	*35433	472	--
II	e3	*35911	474 (Iveco)	--
II	e3	01*36030	474 (Iveco)	--
II	e3	*36709	340 / 341	--
II	e3	*36710	473 (Iveco)	--
II	e3	*36726	600 (Fiat)	--
II	e11	01*3701	255	--
II	e11	01*3706	364	32
II	e11	01*3709	257	--
II	e11	01*3716	253	48
II	e11	01*3717	252	68
II	e3	*37469	475 (Iveco)	--
II	e3	*38090	472	--
III	e	01*38334	600 (Fiat)	--
II	e3	01*38662	475 (Iveco)	--
II	e3	01*3890	472	--
II	e3	02*3890	472	--
II	e3	01*38930	475 (Iveco)	--
II	e3	01*38961	475 (Iveco)	--
II	e3	01*39267	475 (Iveco)	--
II	e3	02*39267	475 (Iveco)	--
II	e3	01*39542	475 (Iveco)	--
II	e3	*40142	250	68
II	e3	01*40458	473 (Iveco)	--
II	e3	02*40458	473 (Iveco)	--
II	e3	01*40459	473 (Iveco)	--
II	e3	02*40459	473 (Iveco)	--
II	e1	*4051	253	48
II	e3	*41511	475 (Iveco)	--
II	e3	01*41877	474 (Iveco)	--
II	e3	*42453	257	--
II	e3	01*42704	253	48
II	e3	01*42928	258	--
II	e3	02*43355	264	--
II	e3	02*43356	264	--
II	e3	02*43360	472	--
II	e3	*43611	364	32
II	E9	02*4395	286-1	--
II	e3	*44994	258	--
II	E9	024559	1033	62
IV	E9	024559	1033	62
II	e17	00*46002	257	--
II	e3	02*46315	472	--
II	e3	02*46656	460	--
II	E3	01*46656	460	--
V	e3	02*46657	463-1	--
IV	e3	02*46658	462	--
IV	E3	01*46658	462	--
II	e3	02*46919	461	--
II	E3	01*46919	461	--
IVV	e11	01*5002	156/6 BO	--
II	e2	02*5004	348	19,65
IMV	e13	01*51370	264	--
II	e11	01*5340	253	48
II	e11	01*5343	257	--
II	e11	01*5383	258	--
II	e11	01*5387	255	--
II	e11	01*5392	364	32
II	e11	01*5393	254	48
II	e11	01*5394	252	68
II	e11	01*5395	251	32
II	e11	01*5396	341	30
IV	e11	01*5398	261	--
IV	e11	01*5399	266	31
IV	e11	01*5420	260	30
II	e11	01*5421	249 L	57
V	e11	01*5422	265	31
II	e11	01*5464	254	48
IVV	e11	01*5465	156/6 BO	--
III	e11	01*5502	200 (Ford)	--
II	e3	02*56297	348	19,65
II	E3	01*56297	470	--
II	e3	02*57571	461	--
II	E3	01*57571	461	--
II	e3	02*58121	460	--
II	E3	01*58121	460	--
IV	e3	02*58232	462	--
IV	E3	01*58232	462	--
II	e11	03*6208	224	72
II	E11	02*6208	224	72
IV	e11	03*6209	224	72
IV	E11	02*6209	224	72
IV	e9	03*6450	580	39

e	E	Typ · type tipo · тип	Tip	
IV	e6	02*6565	261	--
II	e6	02*6566	252	68
II	E6	00*6566	252	68
II	e9	02*6569	373	18,34
II	E9	02*6569	373	18,34
II	E9	02*6909	1049	24
II	E9	02*6950	1049	24
IV	E3	02*7010	462	--
IV	E3	02*7012	462	--
II	e3	03*7018	460	--
V	e3	03*7024	463-1	--
II	E6	00*7059	253	48
II	e6	02*7060	253	48
II	e2	02*717	289	80
II	e2	00*718	249 L	--
II	E13	08*7293	253	48
II	e2	02*739	253	48
II	e2	02*740	258	--
II	e2	02*752	286	--
II	E2	00*752	286	--
IVV	E2	00*753	287-1	--
II	E2	00*759	254	48
V	e6	02*8104	263	--
III	e13	00*86246	39.3730.210H	--
			39.3730.410H	--
IV	e13	01*87290	264	--
IV	E13	01*87290	264	--
V	e13	01*87291	264	--
IV	E13	01*87291	264	--



MEKRA Lang GmbH & Co. KG hat diesen Katalog sorgfältig verfasst. Das Unternehmen enthebt sich jeglicher Verantwortung für eventuelle Fehler oder Auslassung hinsichtlich Schemen, Zeichnungen, Übereinstimmung mit O.E. Codes usw. und behält sich das Recht vor, ohne Ankündigung, am Inhalt Veränderungen vorzunehmen. Anmerkungen, Fehlerhinweise und weitere Anregungen seitens der Kunden werden gerne entgegen genommen, um die nächste Ausgabe des Kataloges effizienter zu gestalten.

Die Vervielfältigung, auch teilweise, des urheberrechtlich geschützten Inhalts des vorliegenden Kataloges ist ohne schriftliche Genehmigung durch die MEKRA Lang GmbH & Co. KG untersagt.

Sämtliche im Katalog genannten Sachnummern der Fahrzeughersteller und deren Markennamen sowie Prüfnummern anderer Spiegelhersteller dienen lediglich zu Vergleichszwecken.



MEKRA Lang GmbH & Co. KG has devoted its best attention to the editing of this catalogue; it nevertheless declines any responsibility for possible mistakes or omissions regarding figures, drawings, correspondence with O.E. codes etc. and it reserves the right to modify the contents without prior notice. Users' comments, reports of inaccuracies or any other suggestions which may in any way improve the next edition of this catalogue are warmly welcomed.

It is forbidden to reproduce, even partially, the contents of this catalogue without prior written consent of MEKRA Lang GmbH & Co. KG, who will protect its right in accordance with the law.

All vehicle manufacturers' reference numbers, mentioned in the catalogue, as well as their brand names and approval numbers of other mirror manufacturers are only for identification purposes.

Vergleichsliste nach OE-Nummern Cross-reference-table

OE		
Agco		
F743810150020	40.1009.421.002	81
F743810150030	40.1009.422.002	81
Adria Mobil		
9090 83003 00	20.2710.650	45
9095 83001 00	59.2760.005.001	--
9095 83001 00 A	59.2761.302	--
9095 83002 00	59.2760.006.001	--
9095 83010 00	59.1018.001.099	84
9095 83011 00	59.1018.002.099	84
9095 83012 00	12.1018.001.099	84
9095 83013 00	12.1018.002.099	84
9095 83014 00	12.1018.007.099	84
9095 83015 00	12.1018.009.001	84
9095 83016 00	12.1018.010.001	84
9095 83017 00	09.2910.005.099	84,87
9095 83018 00	09.2910.002.099	84,87
9095 83021 00	59.1018.025.001	--
RD 322 077 0	11.3730.210H	18,44,80,85
RD 322 244 0	19.1018.311.099	84
Bürstner		
202204008	11.3730.210H	18,44,80,85
2193829	12.1018.001.099	84
2193831	12.1018.002.099	84
2193831 MIT ANT	12.1018.012.001	--
2193839	12.1018.009.001	84
2193840	12.1018.010.001	84
2193841	12.1018.007.099	84
2218516	09.2910.002.099	84,87
2218519	09.2910.005.099	84,87
2247710	59.1018.021.001	--
2247727	59.1018.022.001	--
2247751	59.1018.023.001	--
2276379	59.1018.007.099	84
2304574	12.1018.005.099	84
2613741	59.1018.025.001	--
Z60000	20.2710.650	45
298889	51.3200.147H	30
68152322	59.2782.120	--
70025517	59.2910.003.001	86
70026237	59.2910.500.001	--
70026787	59.2781.120	45
70026788	20.2710.630	21
70026789	59.2910.017.001	86
70026790	61.2910.005.001	87
70026792	09.2910.002.099	84,87
70027178	61.2910.006.001	87
70027665	51.2540.140H	48
70028068	61.2530.110H	48
70029007	59.2770.210.099	46
70029251	15.2780.840	45,47,87
70029917	19.2910.001.099	47,87
70029941	15.2780.840	45,47,87
70029942	15.2780.870	45
70030418	59.2780.110	--
70030686	11.2910.007.000	87
70030687	11.2910.006.000	87
70030688	20.2780.631	--
70030875	19.2910.002.099	47,87
70030923	59.2780.120.099	45
70031268	11.2910.002.000	87
70031577	11.2910.001.000	87
70031996	11.2910.008.000	87
70032095	11.2910.003.000	87
70032122	61.2910.011.002	--
70032360	59.2910.014.001	86
70032377	59.2910.013.001	86
70033394	59.2910.009.001	86
70034438	61.2910.012.002	--
70034479	19.2910.001.099	47,87
70034480	19.2910.002.099	47,87
70034551	59.2780.160.001	--
70036218	61.2910.010.002	--
70036219	11.2910.011.002	87
70036220	61.2910.009.002	--
70036705	15.3802.840H	80
70037106	20.2710.620	44,45,89
70037291	11.2910.012.002	87
Carthago		
118016	20.2710.121	85
118017	20.2710.630	--
118023	20.2710.111H	85
118029	20.2710.200H	44,85
120565	56.3491.110H	57,73
120666	56.3492.110H	57,73
201619	12.1018.001.099	84
201620	12.1018.002.099	84
201621	12.1018.007.099	84
201622	12.1018.007.099	84
201623	12.1018.008.000	--
201624	12.1018.008.000	--
201931	09.2910.004.099	87
201932	15.2780.841F	45,84,87
201933	19.1018.311.099	84
201934	19.1018.312.099	84
203722	59.2910.019.001	86
203723	59.2910.020.001	86
207192	59.1018.007.099	84

OE		
207193	59.1018.008.099	84
207194	12.1018.005.099	84
207195	12.1018.009.001	84
207196	12.1018.010.001	84
107977	51.1009.017.099	81
110485	51.1009.246.001	--
112137	51.2510.127H	32
372807603	51.1009.025.099	--
3728076-03	51.1009.025.099	81
Case New Holland (CNH)		
00437650	51.3850.227	78
47922739	51.1036.009.099	83
47922741	51.1036.010.099	83
47922743	51.1036.007.099	83
47922744	51.1036.008.099	83
48025196	19.1036.005.099	83
48025209	19.1036.006.099	83
236-5334	09.2500.300	--
290-5544 / 319-6789	51.3635.201	80
294-1991 / 316-6791	51.3635.204	80
294-1992	51.3636.204	80
308-3844	15.3731.470H	18,44,85
319-6787	11.3730.210H	18,44,80,85
319-6788	51.3636.201	80
319-6790	51.3636.204	80
372-8075	51.1009.017.099	81
372-8076	51.1009.246.001	--
415-3114	56.2660.147H	31
436-2886	51.1009.027.099	81
436-2887	51.1009.242.099	81
436-2890	20.1016.004.000	90
438-6751	09.3200.340	--
443-2540	51.1009.248.001	--
443-2541	51.1009.243.001	--
443-2541	51.1009.244.001	--
508-0795 ALT	51.1009.009.099	81
526-5057	51.1009.001.099	81
Claas		
11578380	40.1009.004.099	81
11578530	11.1009.004.000	--
11578540	51.1009.048.099	--
11578550	40.1009.002.099	81
11617700	11.1036.011.099	83
11617720	11.1036.012.099	83
11617730	19.1036.007.099	83
11617740	19.1036.008.099	83
11653120	40.1009.001.000	81
11653140	40.1009.421.002	81
11653170	40.1009.422.002	81
11654100	51.1009.001.099	81
11654110	61.1009.001.099	81
11654120	61.1009.002.099	81
11683170	40.1009.002.000	81
11683190	51.1009.049.099	81
1817890	11.3400.510	--
21971360	51.1009.097.099	81
22332170	51.1009.113.099	81
26079370	51.1036.023.099	83
26079500	51.1036.024.099	83
26143870	51.1009.017.099	81
30331340	8.1038.003.099	82
30331350	8.1038.004.099	82
5591600	56.2660.003.001	--
5806090	40.3300.318	--
5854370	51.3300.137	--
6259300	40.3305.218	--
6439980	56.2650.121H	31
Concorde		
248268	59.2910.013.001	86
248269	59.2910.014.001	86
28421	15.2780.840	45,47,87
284213	59.2910.019.001	86
284214	59.2910.020.001	86
284215	59.2910.001.001	86
284215-01	11.2910.011.002	87
284215-03	61.2910.011.002	--
284215-07/28421	19.2910.001.099	47,87
284215-10	15.2780.840	45,47,87
284215-10/28421	15.2780.840	45,47,87
284216	59.2910.002.001	86
284216-01	11.2910.012.002	87
284216-02	11.2910.008.000	87
284216-03	61.2910.012.002	--
284217	61.2910.021.001	87
284218	61.2910.022.001	87
284217-3	61.2770.901.099	46
284221	09.2910.002.099	84,87
284222	20.2710.650	45
284223	20.2710.630	--
284224	59.2780.130	--
2842241	11.2780.910	45
284225	59.2780.230	--
2842251	11.2780.920	45
284226	15.2711.114	44,85
284228	15.2712.114	44,85
284230	59.2710.401H	85
284232	59.2710.402H	85
284233	59.2710.406	85
284237	20.2710.500	--

OE		
2842372	11.3730.210H	18,44,80,85
284240	20.2480.216H	44,56,85,89
284242	20.2480.217H	44,56,85,89
284248	15.3731.470H	18,44,85
284260	59.1018.003.099	84
284261	59.1018.004.099	84
284262	12.1018.001.099	84
284263	12.1018.002.099	84
284264	12.1018.003.099	84
284265	12.1018.009.001	84
284266	12.1018.010.001	84
284267	09.2910.005.099	84,87
284273	59.2910.009.001	86
284274	59.2910.010.001	86
284277	59.2910.017.001	86
284278	59.2910.018.001	86
284281	19.2910.002.099	47,87
284282	11.2910.016.000	--
284283	11.2910.017.000	--
284284	11.2910.014.000	--
DAF		
1055967	59.1005.006.001	--
1401046	59.5580.147	65
1404868	61.3482.149H	19,64
1404871	61.3480.149H	19,64
1405295	61.3480.149H	19,64
1405350	61.3482.149H	19,64
1409570	59.5580.147	65
1409962	59.5580.247H	65
1425104	61.3730.324H	18
1425105	61.3730.326H	18
1425108	61.3860.214H	18
1425109	15.3731.470H	18,44,85
1425111	15.3861.114H	18
1425113	11.3730.210H	18,44,80,85
1425114	11.3860.500H	18
1525537	59.5520.530H	78
1525547	59.3652.167H	--
1525548	59.3652.147H	--
1525593	56.1561.116H	--
1525594	56.1561.115H	--
1525630	51.3640.127	--
1525672	51.1523.111H	--
1525673	51.1522.211H	--
1525685	40.3200.422H	30
1526649	59.5580.247H	65
1527629	59.5580.147	65
1542333	51.3635.206	80
1542334	51.3636.206	80
1545467	61.3900.130H	24
1610182	15.3862.174H	18
1610184	61.3730.326H	18
1610186	61.3730.324H	18
1610187	61.3860.214H	18
1610189	61.3865.124H	18
1610190	15	

Cross-reference-table Vergleichsliste nach OE-Nummern

OE			OE			OE		
1735523	61.3911.120H	24	2424900	59.1027.003.099	22	87902007G	15.3802.840H	80
1736853	58.3900.233H	--	2424901	59.1027.004.099	22	87902008	61.9065.114H	18
1736854	58.3900.133H	--	2424902	12.1027.103.099	22	87902008G	15.9060.870H	18
1736865	15.3911.872H	24	2424903	12.1027.104.099	22	87930-0008A	59.2652.110H	31
1736879	15.3911.871H	24	2424904	12.1027.203.099	22	Hymmer		
1736883	11.3910.200H	24	2424905	12.1027.204.099	22	0850034	40.3640.322H	32
1736884	11.3900.200H	24	2430046	61.1000.105.199	25	1015718	55.2020.177H	--
1736923	20.3900.520H	24	2430047	61.1000.006.199	25	1287034	59.2761.302	--
1736924	20.3900.510H	24	2430048	61.1000.007.199	25	1289691	20.2480.222	--
1736951	58.3900.433H	24	2430049	13.1000.601.199	25	1299452	20.2700.200H	44,85
1736952	58.3900.333H	24	2430050	13.1000.602.199	25	1316712	58.2704.065	--
1736953	58.3900.233H	24	2430051	13.1000.603.199	25	2668945	11.2780.920	45
1736954	58.3900.133H	24	2430052	19.1000.601.199	25	2673925	20.2710.620	44,45,89
1737933	15.3900.840H	24	2430053	19.1000.602.199	25	2674190	51.3200.137H	--
1781224	61.3902.110H	24	2430054	19.1000.603.199	25	2698041	40.3640.322H	32
1781225	61.3902.120H	24	2430055	20.1000.611.199	25	2698081	09.3200.360	--
1781226	61.3902.100E	--	2430056	20.1000.612.199	25	2698087	56.1471.117	--
1781227	61.3913.110H	24	2430057	20.1000.613.199	25	2725823	11.3730.210H	18,44,80,85
1781228	61.3913.120H	24	2430058	20.1000.614.199	25	2726750	59.2761.112	--
1788487	58.5710.001.099	21	2436404	58.1000.611.199	25	2771210	40.2500.322	--
1788972	58.5713.114.099	21	2436405	58.1000.612.199	25	2943025	20.2760.140	--
1796324	61.3482.149H	19,64	2436406	58.1000.613.199	25	2943027	20.2760.150	--
1805712	61.3480.149H	19,64	2436407	58.1000.614.199	25	38 305	56.1471.117	--
1805713	40.3485.412H	19,64	2436408	58.1000.621.199	25	383183	51.2510.127H	32
1805714	61.3481.149H	19,64	2436409	58.1000.622.199	25	V110-02-005	40.3640.322H	32
1805717	15.3480.840H	19,64	2436410	58.1000.623.199	25	Irisbus		
1812859	58.5713.114.099	21	2436411	58.1000.624.199	25	42545989	15.2712.114	44,85
1812862	61.5700.310.099	20	2436412	58.1000.641.199	25	42545990	11.3730.210H	18,44,80,85
1812865	09.5700.002.099	20	2436413	58.1000.642.199	25	42548988	15.2711.114	44,85
1812867	58.5701.104.099	21	1404849 / 1796325	40.3485.403H	19,64	5006232165	58.2704.088	91
1816902	59.5595.131H	20	FORD			5006232166	58.2704.089	--
1816903	59.5595.132H	20	191114	59.1049.014.099	27	5006232482	51.3732.326	44,85
1816905	59.5595.134	--	1823808	12.1049.002.099	26,27	71101611	59.2710.411	--
1816906	59.5595.135	--	1823809	12.1049.001.099	26,27	71101611/612 SO	20.2710.200H	44,85
1816907	59.5595.136	--	1823985	19.1049.004.099	26,27	71101612	59.2710.412	--
1816912	59.5595.235H	20	1823986	19.1049.001.099	26,27	71701878	09.3200.220	88
1816913	59.5595.236	20	1823994	19.1049.003.099	26,27	Iveco		
1816914	59.5595.331H	20	1823995	19.1049.002.099	26,27	42309921	51.1523.111H	--
1816915	59.5595.332	20	1855102	19.1049.006.099	26,27	42545983	59.2710.412	--
1817860	61.5710.310.099	20	1855103	19.1049.005.099	26,27	42545985	20.2480.217H	44,56,85,89
1818353	58.5710.001.099	21	1911158	59.1049.013.099	27	4256227	11.3730.210H	18,44,80,85
1830338	61.5590.001.099	20,87	2043755	08.1049.002.099	26,27	42566228	15.3731.470H	18,44,85
1830562	58.5700.001.099	21	2085655	08.1049.001.099	26,27	500086749	192.790.012.099	29
1882111	12.5700.002.099	21	2085657	08.1049.004.099	26	500086750	192.790.011.099	29
1882112	12.5700.004.099	21	2208678	08.1049.003.099	26	500086753	192.790.031.099	29
1882113	12.5740.002.099	20	2365898	59.1049.006.099	26	500086754	192.790.032.099	29
1882126	12.5700.001.099	21	2365901	59.1049.008.099	26	5001851891	11.2810.200H	56
1882127	12.5700.003.099	21	2365911	59.1049.010.099	26	5010404852	59.2810.113H	56
1904296	85752024099	24	2365917	59.1049.004.099	26	5010411090	59.2810.111H	56
1940334	58.5700.003.099	21	2365929	59.1049.002.099	26	503449902	11.2770.920	46
1940335	58.5700.004.099	21	2365947	59.1049.005.099	26	503449909	15.2771.840	46
1940341	61.5740.001.099	20	2365950	59.1049.007.099	26	503651179	11.2770.920	46
1940342	19.5740.311.099	20	2366799	59.1049.009.099	26	504150526	59.1008.005.099	28
1949304	59.1005.001.099	21	2366803	59.1049.003.099	26	504150527	59.1008.006.099	28
1949305	59.1005.002.099	21	2366812	59.1049.001.099	26	504150538	59.1008.011.099	28
2248157	59.1027.001.099	22	BK31-17682-NA5JA	59.1049.014.099	27	504150539	59.1008.012.099	28
2248159	59.1027.002.099	22	BK31-17683-JJ5J6A	59.1049.012.099	27	504150551	59.1008.017.099	28
2248160	59.1027.103.099	22	BK31-17683-JJ5J6A	59.1049.011.099	27	504150552	59.1008.018.099	28
2248161	59.1027.104.099	22	BK31-17683-NA5JA	59.1049.013.099	27	504168236	56.1008.002.099	28
2248164	12.1027.001.099	22	KK3117682LB5JA	59.1049.010.099	26	504168237	56.1008.003.099	28
2248165	12.1027.002.099	22	KK3117683LB5JA	59.1049.001.099	26	504168238	56.1008.004.099	28
2248166	12.1027.005.099	22	Eura Mobil	59.1018.001.099	84	504168244	11.1008.001.099	28
2248167	12.1027.006.099	22	200070726	59.1018.002.099	84	504197878	19.1008.041.099	28
2248168	12.1027.015.099	22	200070727	59.1018.000.099	84	504197879	19.1008.311.099	28
2248169	12.1027.016.099	22	200070749	09.2910.005.099	84,87	504224428	55.1008.002.099	29
2248172	12.1027.107.099	22	200070751	09.2910.002.099	84,87	504369910	59.1008.005.099	28
2248173	12.1027.108.099	22	200070813	12.1018.007.099	84	504369911	59.1008.006.099	28
2248174	12.1005.001.099	23	200070814	12.1018.009.001	84	504369912	59.1008.017.099	28
2248175	59.1027.003.099	22	200070817	12.1018.001.099	84	504369913	59.1008.018.099	28
2248176	59.1027.004.099	22	200070820	12.1018.002.099	84	504370048	59.1008.011.099	28
2248178	59.5590.013.099	23	200070822	12.1018.010.001	84	504370055	59.1008.012.099	28
2248179	59.5590.014.099	23	200083487	59.2760.005.001	--	5801334610	59.1008.006.099	28
2248184	12.5590.009.099	23	200083496	59.2760.006.001	--	5801336285	59.1008.005.099	28
2298758	59.1027.203.099	22	V110-01-008B	11.3730.210H	18,44,80,85	5801336286	59.1008.011.099	28
2298759	59.1027.204.099	22	V110-02-001	51.3400.147H	30	5801336287	59.1008.012.099	28
2298826	12.1027.207.099	22	V110-02-004	09.3200.340	--	5801341206	59.1008.017.099	28
2298827	12.1027.208.099	22	Fendt/Valtra			5801341207	59.1008.018.099	28
2306586	61.1029.224.099	22	F297810150010	40.2890.222H	78,80	5801404796	59.2770.211.099	46
2306587	61.1024.224.099	22	F304810150030	40.1009.002.000	81	5801404799	59.2762.101	44
2306590	19.1027.011.099	22	F743810150010	40.1009.001.000	81	5802498968	112.790.001.099	29
2306591	19.1027.012.099	22	G297810150030	51.3850.127H	78	5802498969	112.790.002.099	29
2306592	19.1027.013.099	22	G304810150020	51.1009.017.099	81	John Deere		
2306593	19.1027.312.099	22	G816810150030	51.2890.117H	80	AKK34593	51.1009.113.099	81
2346204	59.5590.013.099	23	ACV0148490	51.1009.097.099	81	AL158964	51.3850.127H	78
2346205	59.5590.014.099	23	ACV0759270	40.1009.004.099	81	AL203151	15.5701.840H	20
2352946	59.1027.003.099	22	ACV0759280	40.1009.002.099	81	AL225823	19.1036.007.099	83
2363198	59.1000.611.199	25	ACV0805960	51.1009.017.099	81	AL225824	19.1036.008.099	83
2363200	59.1000.612.199	25	Heuliez	15.2780.840	45,47	AL232743	51.1036.009.099	83
2363202	59.1000.613.199	25	50344917			AL232744	51.1036.010.099	83
2363204	59.1000.614.199	25	HINO			AZ100260	56.2650.121H	31
2363207	59.1000.642.199	25	879020002	51.3300.147H	--	AZ100261	11.1523.010	--
2363212	59.1000.621.199	25	879020008C	11.9060.100H	18	AZ104094	51.3636.205	--
2363214	59.1000.622.199	25	879020009	59.3604.178H	--	AZ104180	51.3635.205	--
2363216	59.1000.623.199	25	87902					

Vergleichsliste nach OE-Nummern Cross-reference-table

OE		
8.688.000.256.0	09.3200.320H	88
8.688.032.13.0	10.6321.100	30,31
8.688.100.253.0	40.2890.422H	78,80
8.688.105.262.0	09.3200.340	--
8.688.105.264.0	11.3730.210H	18,44,80,85
8.688.117.000.0	51.1009.250.001	--
8.688.120.000.0	51.1009.001.099	81
8.688.128.000.0	59.1017.003.099	82
8.688.129.000.0	59.1017.004.099	82
8.748.026.000.0	55.2462.117	--
8.748.036.000.0	56.1562.110	--
814.67.10.100.1	51.2520.147H	68
86881000000	51.3850.247	78
86881050000	51.3635.206	80
86881052630	15.3802.840H	80
86881060000	51.3636.206	80
99707305609	40.2660.404H	31
Komatsu		
21D-54-41710	51.1009.017.099	81
42154H3380	51.1009.025.099	81
42154H3480	51.1009.017.099	81
Kramer		
1000379630	51.1009.022.099	81
1000379641	51.1009.122.099	81
1000386860	51.1009.017.099	81
1000390196	51.1009.149.099	81
1000396261	51.1009.097.099	81
Liebherr		
10218823	55.3000.108H	--
10285254	55.2020.177H	--
10287949	51.3636.206	80
10287953	51.3635.206	80
10300676	56.2600.127H	30
10303351	51.3640.137H	32
10334227	11.3730.210H	18,44,80,85
10342167	09.2070.101H	30,32,48,68,80,88
10470601	15.3802.840H	80
10472808	58.2600.010H	--
10472809	56.2660.147H	31
10675116	40.2635.204F	--
10877369 / 5707 57877	51.2520.127H	68
11008727	51.3640.128.001	--
11066581	58.2704.075.001	--
11068341	51.1009.017.099	81
11181691	51.1009.049.001	--
11182172	09.2070.101H	30,32,48,68,80,88
1118692	09.2000.301H	30,31,78,81,88
11657850	61.3480.149H	19,64
11657851	58.1016.001.099	90
11657852	58.1016.002.099	90
11657853	58.1016.005.099	90
11657854	58.1016.006.099	90
11657855	20.1016.004.000	90
11830241	11.1200.502.099	--
11830530	59.1005.004.001	--
11931048	20.2710.630	--
12218370	59.1005.004.001	--
12230063	40.1009.001.000	81
12230064	40.1009.003.099	--
12254474	09.3200.320H	88
12269787	58.1016.004.099	90
571070008	09.2070.101H	30,32,48,68,80,88
571229808	40.2520.422H	68
571572108	09.3200.340	--
571572208	09.3200.220	88
571757008	08.3492.324.099	--
591055977	59.2640.110H	--
591056608	51.2520.147H	68
591059377	56.2660.127H	31
591060808	56.2640.127H	--
591061008	56.2661.147	--
591069208	09.3200.440	--
591070908	56.2630.127	--
591077608	58.2704.042	--
591080008	58.2486.507	--
7004956	51.1524.119H	80
7005028	51.3640.127	--
7017444	56.2660.127H	31
7021442	51.3640.147H	32
7022092	51.2461.117H	--
7616670	51.1523.121H	--
7619627	55.2021.177	--
7621216	20.2480.210H	89
7621717	51.2530.128H	--
Lindner		
3006104	51.3495.112H	73
3006232	56.3492.110H	57,73
3006233	56.3491.110H	57,73
3009960	51.1009.043.001	--
3009961	58.1017.011.099	82
3009999	58.1017.012.099	82
3010115	51.1009.001.099	81
3010188	51.1009.081.099	81
3010662	51.1009.017.099	81
3010850	51.1009.021.099	81
3010851	51.1009.022.099	81
3010852	51.1009.121.099	81
3010853	51.1009.122.099	81
3022116	40.1009.001.000	81

OE		
3205677	40.1009.004.099	81
3205678	40.1009.002.099	81
3207388	40.1009.002.000	81
3207415	11.1009.004.000	--
MAN		
11075175	59.2762.101	44
16100772027	09.3400.420	30,78,88
33.25203-6001	08.2910.001.002	46,87
33.25404-6190	09.2770.211	--
33.28104-6355	09.1041.004.099	47
33.63700-6003	59.1042.005.099	47
33.63700-6004	59.1042.001.099	47
33.63730-6003	51.3635.206	80
33.63731-6002	58.2705.002	--
336373060001	51.3850.267	78
36.25404-6033	09.1041.002.099	47
36.63700-6017	59.1042.001.099	47
36.63700-6018	59.1041.001.099	47
36.63700-6019	59.1042.003.099	47
36.63700-6020	59.1042.004.099	--
36.63700-6022	59.1042.002.099	--
36.63730-6013	56.1523.117H	--
36.63730-6024	59.2910.500.001	--
36.63731-6000	20.2710.620	44,45,89
36.63731-6001	20.2710.630	--
36.63731-6012	20.1042.002.099	47
36.63731-6013	20.1042.003.099	47
36.63732-0000	11.2770.102	46
36.63732-0001	11.2770.302	46
36.63732-0002	11.2770.202	46
36.63732-0003	11.2770.402	46
36.63732-0004	11.2770.620	--
36.63732-0006	11.2780.920	45
36.63732-0024	61.2910.009.002	--
36.63732-0033	12.1041.004.099	--
36.63732-0034	12.1041.003.099	47
36.63732-0036	12.1041.005.099	47
36.63732-0037	12.1041.001.099	47
36.63732-0040	12.1042.001.099	--
36.63732-0041	12.1042.002.099	47
36.63732-0044	11.2910.017.000	--
36.63732-6000	61.2770.900.099	46
36.63733-0009	19.2910.002.099	47,87
36.63733-0010	19.2910.001.099	47
36.63733-0011	15.2780.840	47
36.63733-0012	19.2910.002.099	47
36.92611-0002	11.2770.040	--
65.63733-0002	19.1013.011.099	43
65.63733-0006	19.1013.013.099	43
65.63733-0014	19.1013.013.099	43
65.63733-0015	19.1013.011.099	43
81.25404-6247	09.3200.310H	--
81.25406-6252	09.3200.360	--
81.25432-0149	09.2070.101H	30,32,48,68,80,88
81.25505-6247	08.2770.001.000	46
81.25525-0232	08.3200.233H	45,46,84,87,88
81.62410-0107	20.5800.710H	39
81.62410-0108	20.5800.720H	39
81.62410-0109	20.5800.750H	39
81.62730-6221	51.3410.147H	30
81.63732-0089	61.2772.100	46
81.63730-0032	40.3640.422H	30,32
81.63730-6127/-6167	51.2510.127H	32
81.63730-0058	08.3400.324	--
81.63730-0067	15.3731.074H	34
81.63730-0082	61.2770.110	--
81.63730-0083	61.2770.210	46
81.63730-0066	15.3731.070H	--
81.63730-6001	51.3640.147H	30,32
81.63730-6003	40.3640.422H	30
81.63730-6016	51.3400.147H	30
81.63730-6094	51.2460.218H	--
81.63730-6108	51.3640.127H	32
81.63730-6126	51.3640.127H	32
81.63730-6128	51.2510.147H	32
81.63730-6138	56.1562.110	--
81.63730-6147	51.3640.127H	32
81.63730-6148	51.3640.127H	32
81.63730-6149	51.3640.127H	32
81.63730-6151	51.3640.147H	32
81.63730-6193	51.3200.147H	30
81.63730-6194	51.3640.127H	32
81.63730-6202	40.3640.422H	30,32
81.63730-6206	56.2600.127H	30
81.63730-6220	51.3410.127H	30
81.63730-6221	51.3410.147H	30
81.63730-6222	56.2660.127H	31
81.63730-6223	56.2660.147H	31
81.63730-6224	56.2650.121H	31
81.63730-6233	51.3410.127H	30
81.63730-6234	51.3410.147H	30
81.63730-6235	56.2660.127H	31
81.63730-6236	56.2660.147H	31
81.63730-6237	59.2852.110H	31
81.63730-6294	59.3652.128H	31
81.63730-6295	59.3652.147H	--
81.63730-6296	59.3652.167H	--
81.63730-6299	56.2660.147H	31
81.63730-6303	51.3736.121H	--

OE		
81.63730-6305	51.3736.126H	34
81.63730-6306	56.3860.112H	34
81.63730-6307	56.3860.114H	34
81.63730-6308	56.3862.116H	34
81.63730-6314	51.3735.121H	--
81.63730-6315	51.3735.124H	34
81.63730-6316	51.3735.126H	34
81.63730-6317	56.3861.116H	34
81.63730-6328	56.3862.116H	34
81.63730-6331	51.3735.121H	34
81.63730-6332	51.3736.121H	--
81.63730-6345	51.3921.222H	36
81.63730-6347	51.3922.222H	36
81.63730-6350	56.3932.222H	--
81.63730-6351	56.3931.222H	--
81.63730-6361	51.3735.124H	34
81.63730-6362	51.3736.124H	34
81.63730-6363	51.3735.126H	34
81.63730-6364	51.3736.126H	34
81.63730-6365	51.3735.124H	34
81.63730-6366	51.3736.124H	34
81.63730-6367	51.3735.126H	34
81.63730-6368	51.3736.126H	34
81.63730-6369	51.3922.232H	--
81.63730-6373	08.3492.324.099	--
81.63730-6374	51.3732.326	44,85
81.63730-6375	51.3731.326	44,85
81.63730-6390	51.3732.326	44,85
81.63730-6394	51.3924.222H	--
81.63730-6395	51.3921.222H	36
81.63730-6398	51.3923.222H	36
81.63730-6401	51.3922.232H	--
81.63730-6409	56.3931.222H	--
81.63730-6410	56.3932.222H	--
81.63730-6420	51.3412.120H	30
81.63730-6421	56.2662.120H	31
81.63730-6430	51.3921.222H	36
81.63730-6431	51.3924.222H	--
81.63730-6432	51.3922.222H	36
81.63730-6433	51.3923.222H	36
81.63730-6434	51.3922.232H	--
81.63730-6443	56.3931.222H	--
81.63730-6444	56.3932.222H	--
81.63730-6480	51.3921.223H	37
81.63730-6481	51.3922.223H	37
81.63730-6482	51.3921.224H	37
81.63730-6483	51.3922.224H	37
81.63730-6484	51.3924.223H	--
81.63730-6485	51.3923.223D	37
81.63730-6486	51.3924.224H	37
81.63730-6487	51.3923.224H	--
81.63730-6492	51.3922.233H	--
81.63730-6510	56.3931.343H	37
81.63730-6511	56.3932.343H	37
81.63730-6512	56.3931.323H	37
81.63730-6513	56.3932.323H	37
81.63730-6529	59.5800.101H	39
81.63730-6531	59.5800.201H	39
81.63730-6533	59.5800.121H	39
81.63730-6534	59.5800.221H	39
81.63730-6549	59.5800.122H	39
81.63730-6550	59.5800.222H	39
81.63730-6551	59.5800.422H	39
81.63730-6552	59.5800.322H	39
81.63730-6553	59.5800.223H	39
81.63730-6560	59.5800.102H	39
81.63		

Cross-reference-table Vergleichsliste nach OE-Nummern

OE		
81.63730-6843	56.1020.020.099	41
81.63730-6844	56.1020.019.099	--
81.63730-6845	56.1020.017.099	41
81.63730-6846	56.1020.018.099	41
81.63730-6853	59.1024.009.099	40
81.63730-6854	59.1024.010.099	40
81.63730-6855	59.1024.027.099	40
81.63730-6856	59.1024.028.099	40
81.63730-6859	59.1024.001.099	40
81.63730-6860	59.1024.002.099	40
81.63730-6861	59.1024.023.099	40
81.63730-6862	59.1024.024.099	40
81.63730-6863	59.1024.021.099	40
81.63730-6865	59.1024.017.099	40
81.63730-6868	59.1024.014.099	40
81.63730-6869	59.1024.013.099	40
81.63730-6870	59.1024.030.099	40
81.63730-6871	59.1024.029.099	40
81.63730-6874	59.1024.006.099	40
81.63730-6875	59.1024.005.099	40
81.63730-6876	59.1024.026.099	40
81.63730-6877	59.1024.025.099	40
81.63730-6878	59.1024.019.099	40
81.63730-6879	59.1024.022.099	40
81.63730-6881	56.1020.015.099	41
81.63731-0111	11.3400.300	--
81.63731-0157	20.2600.111H	--
81.63731-0158	20.2600.112H	--
81.63731-0286	11.3920.300H	--
81.63731-0289	20.2710.200H	44,85
81.63731-0298	11.3400.510	--
81.63731-0302	20.2710.500	--
81.63731-0309	11.3921.400	37,38
81.63731-0356	11.5800.100H	39
81.63731-0366	11.3921.400	37,38
81.63731-0372	61.2770.111	--
81.63731-0373	61.2770.211	46
81.63731-0380	11.5800.200H	39
81.63731-0397	11.5800.100H	39
81.63731-6468	20.2710.121	85
81.63731-6469	20.2710.111H	85
81.63731-6470	20.2480.217H	44
81.63731-6471	20.2480.221	--
81.63731-6474	20.2700.240	--
81.63731-6475	20.2700.230	--
81.63731-6477	58.2710.101	--
81.63731-6478	20.2480.223	89
81.63731-6539	20.2710.132D	--
81.63731-6540	20.2710.142D	--
81.63731-6638	58.5800.101H	39
81.63731-6639	58.5800.102H	39
81.63731-6640	58.5800.201H	39
81.63732-0019	14.2530.100	--
81.63732-0044	11.3800.300H	35
81.63732-0045	11.3810.300H	--
81.63732-0046	51.3736.124H	34
81.63732-0047	51.3736.126H	34
81.63732-0048	56.3862.116H	34
81.63732-0049	56.3861.116H	34
81.63732-0050	56.3860.114H	34
81.63732-0051	51.3735.126H	34
81.63732-0054	11.3921.110H	36,37
81.63732-0056	11.3931.120H	37
81.63732-0057	11.3931.110H	37
81.63732-0058	11.3730.210H	18,44,80,85
81.63732-0059	11.3921.120H	36,37
81.63732-0061	11.3931.110H	37
81.63732-0062	11.3931.120H	37
81.63732-0063	11.3921.120H	36,37
81.63732-0065	11.3931.110H	37
81.63732-0066	11.3931.120H	37
81.63732-0073	20.5800.410H	39
81.63732-0074	20.5800.420H	39
81.63732-0075	20.5800.610H	39
81.63732-0076	20.5800.620H	39
81.63732-0078	11.3810.300H	--
81.63732-0087	11.2770.920	46
81.63732-0088	11.2780.910	45
81.63732-0090	20.5800.750H	39
81.63732-0091	13.5800.100H	39
81.63732-0094	12.3920.001.099	38
81.63732-0095	12.3920.002.099	38
81.63732-0096	12.3930.001.099	38
81.63732-0097	12.3930.002.099	38
81.63732-0098	11.2780.520	--
81.63732-0106	12.1020.003.099	41
81.63732-0110	13.1024.002.099	40
81.63732-0111	13.1024.001.099	40
81.63732-0112	12.1024.012.099	40
81.63732-0113	12.1024.011.099	40
81.63732-0114	12.1024.010.099	40
81.63732-0115	12.1024.009.099	40
81.63732-0125	13.1024.003.099	40
81.63733.0032	40.2510.222H	32
81.63733-0025	40.3640.222H	30,32
81.63733-0030	40.3640.222H	30,32
81.63733-0036	40.3200.422H	30
81.63733-0042	40.2605.204H	30
81.63733-0060	40.3640.222H	30,32
81.63733-0061	40.2665.204H	31

OE		
81.63733-0064	40.3640.422H	30,32
81.63733-0066	15.3731.070H	--
81.63733-0067	15.3731.074H	34
81.63733-0075	15.3731.470H	44
81.63733-0082	15.3921.870H	36
81.63733-0083	15.3922.870H	36
81.63733-0085	15.3931.870H	--
81.63733-0097	15.3811.870H	--
81.63733-0098	15.3811.870H	--
81.63733-0099	15.3946.670F	31
81.63733-0101	40.5725.212H	33
81.63733-0103	40.5725.412H	33,72
81.63733-0104	40.5735.203H	33
81.63733-0106	40.5735.403H	33,72
81.63733-0110	15.2771.840	46
81.63733-0111	15.2771.870	46
81.63733-0112	15.2780.870	45
81.63733-0113	15.2780.840	45
81.63733-0114	15.2561.640	--
81.63733-0115	15.2561.600	--
81.63733-6003	40.3640.422H	30,32
81.63733-6007	40.2660.404H	31
81.63733-6033	15.3921.870H	36
81.63733-6034	15.3922.870H	36
81.63733-6037	15.3931.870H	--
81.63733-6049	15.3920.840H	37
81.63733-6057	15.3932.870H	37
81.63733-6071	15.5801.840H	39
81.63733-6072	15.5811.872H	39
81.63733-6073	15.5811.871H	39
81.63733-6074	15.5791.470H	33,36,51,53
81.63733-6078	15.5791.570.099	33,36,38,39
81.63733-6079	19.3920.011.099	38
81.63733-6080	19.3930.311.099	38
81.63733-6083	19.1024.011.099	40
81.63733-6084	19.1024.012.099	40
81.63733-6085	19.1024.311.099	40
81.63733-6086	19.1024.312.099	40
81.63733-6087	19.1024.213.099	41
81.63733-6088	19.1020.613.099	41
81.63733-6027	15.2711.114	44,85
81.63733-6028	15.2712.114	44,85
81.63733-6029	15.3731.470H	44
81.63734-6001	08.5752.024.099	45,46,62,63,69
81.63734-6006	08.1024.124.099	47
82.25451-6399	09.2500.300	--
82.63730-6015	51.3801.148H	35
82.63730-6016	51.3802.148H	35
82.63730-6017	51.3801.168H	35
82.63730-6018	51.3802.168H	35
82.63730-6021	56.3812.128H	35
82.63730-6022	56.3812.128H	35
82.63730-6023	56.3812.148H	35
82.63730-6024	56.3812.148H	35
82.63730-6025	56.3811.168H	35
82.63730-6026	56.3812.168H	35
82.63730-6033	59.3652.128H	31
82.63730-6034	59.3652.148H	31
82.63730-6035	59.3652.168H	31
83.25402-6010	09.2000.301H	30,31,78,81,88
83.63700-6501	59.2712.114	44
83.63700-6502	59.2712.111	44
83.63700-6510	59.2780.140.001	45
83.63700-6511	59.2780.150.001	45
83.63700-6530	59.1041.003.099	47
83.63731-6507	20.2480.216H	44
85.20000-9601	40.3640.422H	30,32
85.63730-6015	51.3400.147H	33
85.63730-6030	51.5720.120H	33
85.63730-6033	51.5720.140H	33
85.63730-6035	51.5721.160H	33
85.63730-6036	51.5722.160H	33
85.63730-6037	56.5730.120H	33
85.63730-6039	56.5730.140H	33
85.63731-6101	58.3405.261Y	--
85.63731-6102	58.3406.250Y	--
85.63731-6104	58.3406.252Y	--
85.63731-6106	58.3406.254Y	--
85.63731-6107	58.3405.262H	--
85.63731-6108	58.3406.251H	--
85.63731-6109	58.3405.264Y	--
85.63731-6126	58.3402.112Y	--
88.25426-6837	09.2770.210	46
88.25505-0024	09.3200.420H	30,81,83
88.63700-6059	59.2780.120.099	45
88.63700-6060	59.2771.210.099	46
88.63700-6062	59.2770.211.099	46
88.63700-6063	59.2780.110	--
88.63700-6064	59.2770.110	--
88.63730-6041	51.3400.147H	30
88.63730-6077	55.2561.010	--
88.63730-6078	55.2561.110	--
88.63731-6131	20.2780.630	--
A0048208342	08.3400.324	--
AP138274C-2	11.2780.210	45
N1.01103-5783	58.2601.010	--
81.63732-0124	13.1024.004.099	40
Marco Polo		
09379861018	20.2710.121	85

OE		
17294281	20.2710.200H	44,85
172942890	51.3731.326	44,85
Mauser		
6-200.26.185	51.1036.025.099	83
Mercedes		
1505533	09.2070.101H	30,32,48,68,80,88
1590268	09.3200.320H	88
4400015	08.5890.300.099	59,75
4400115	08.5890.301.099	59,75
4400515	08.5890.004.099	--
4401501	08.5890.003.099	--
8100102	51.5720.001.099	--
8100211	20.2810.110H	--
8100279	61.3752.147H	49,56
8100379	61.3752.167H	49,56
8100412	61.2703.110	91
8100416	51.2540.120H	48
8100512	61.2703.120	91
8100616	51.2540.130H	48
8100617	51.2500.127H	68
8100879	56.3960.148H	51,53
8101479	51.5750.004.099	50
8101579	51.5750.002.099	50
8101613	11.3001.100	--
8101679	51.5770.001.099	50
8101779	51.5750.003.099	50
8101879	51.5750.001.099	50
8102016	51.2540.130H	48
8102079	51.5750.001.099	50
8102179	51.5750.002.099	50
8102279	51.5750.003.099	50
8102316	51.2530.140H	48
8102379	51.5750.004.099	50
8102479	51.5770.001.099	50
8102716	51.2530.120H	48
8103613	61.3000.001.001	79
8103713	61.3000.002.001	79
8103716	51.2520.147H	68
8104816	51.2540.120H	48
8105316	51.3200.147H	30
8106216	51.2530.120H	48
8108316	51.3410.147H	30
8109516	61.3782.147H	52
8109616	61.3772.147H	49,52
8110135	14.2530.100	--
8110239	61.2530.110H	48
8110361	20.3750.710.099	49
8110461	20.3750.720.099	49
8110818	11.3491.200	--
8110839	11.3491.300	--
8111122	13.5890.120.199	59,61,75
8111233	51.2530.210H	48
8111307	61.3780.100H	49,51,52,53,56
8111807	20.5750.710.099	50
8111907	20.5750.720.099	50
8111933	40.2540.222H	48
8112007	61.5750.100H	50
8112033	40.2530.222H	48
8112133	40.2530.222H	48
8113333	40.2530.222H	48
8113533	40.2540.222H	48
8114033	15.5891.722.099	59

Cross-reference-table Vergleichsliste nach OE-Nummern

OE		
AP107424C-4	51.3636.206	80
AP119170C-10	11.2910.003.000	87
AP119170C100	59.2910.003.001	86
AP119170C-100	59.2910.003.001	86
AP119170C-11	11.2910.006.000	87
AP119170C-12	11.2910.008.000	87
AP119170C-13	11.2910.002.000	87
AP119170C-14	61.2910.011.002	--
AP119170C-15	11.2910.007.000	87
AP119170C-16	61.2910.012.002	--
AP119170C-17	11.2910.011.002	87
AP119170C-18	11.2910.012.002	87
AP119170C-2	59.2910.010.001	86
AP119170C-5	61.2910.009.002	--
AP119170C-6	61.2910.019.002	--
AP119170C-7	19.2910.001.099	47,87
AP119170C-9	11.2910.011.000	87
AP138271C-1	11.2780.510	--
AP138271C-2	11.2780.910	45
AP138271C-3	15.2780.870	45
AP138274C	59.2780.180.001	45
AP138274C-1	11.2780.520	--
AP140857C-1	59.2910.009.001	86
AP140857C-3	61.2910.005.001	87
AP140857C-4	61.2910.006.001	87
APAA-01976-4	11.3730.210H	18,44,80,85
APAA-01976-6	09.3200.360	--
APAA-01983-3	20.2710.500	--
P105367C15	20.2480.210H	89
P107424C10	20.2480.216H	44,56,85,89
P119170C-3	61.2910.003.001	87
P119170C-4	61.2910.004.001	87
P119170C8	15.2780.840	45,47,87
PAA01976-1	51.3731.326	44,85
PAA019762	15.3731.470H	18,44,85
PAA019763	15.2711.114	44,85
PAA019771	51.3732.326	44,85
PAA019774	15.2712.114	44,85
PAA-01985	09.3200.220	88
Renault		
5001856290	61.3481.149H	19,64
5010578503	59.3900.123H	--
5010578504	59.3900.223H	--
5010578505	59.3901.123H	--
5010578506	59.3901.223H	--
5010578511	59.5580.247H	65
5010623057	20.3900.510H	62
5010623058	20.3900.520H	62
5010623231	59.3900.143H	--
5010623232	59.3900.243H	--
5010623246	59.3900.133H	--
5010623247	59.3900.233H	--
5010623689	59.3901.143H	--
5010623690	59.3901.243H	--
5010623698	59.3901.233H	--
7420849799	59.5524.748.099	--
7420849835	59.5524.649.099	64
7420849837	59.5524.648.099	64,69
7420849852	59.5524.640.099	--
7420850409	20.5520.250H	--
7420862779	11.3900.200H	62
7420862782	61.3900.100H	62
7420862795	15.3900.840H	62
7420862800	11.3910.200H	62
7420862809	61.3911.110H	62
7420862810	15.3911.871H	62
7420862812	08.5752.024.099	45,46,69
7420862813	61.3911.120H	62
7420862815	15.3911.872H	62
7420866665	61.3900.110H	62
7420866672	08.5752.024.099	45,46,69
7420903714	11.3900.201H	--
7420903722	58.3900.143H	62
7420903723	58.3900.133H	62
7420903727	58.3900.243H	62
7420903732	58.3900.233H	62
7420903745	15.3910.871H	62
7420903746	15.3910.872H	62
7420903880	11.3900.100H	62
7420903881	11.3900.101H	--
7420903882	11.3910.110H	62
7420903883	11.3910.120H	62
7420904268	61.3910.110H	62
7420904269	61.3910.120H	62
7420913815	61.3900.120H	24,62
7420914934	58.3900.333H	62
7420914938	58.3900.433H	62
7421020285	51.5524.930H	64,69,79
7421164788	59.5524.730.099	--
7421276373	61.3482.149H	19,64
7421326526	59.3900.233H	--
7421326527	59.3900.243H	--
7421326550	59.3900.223H	--
7421326551	59.3901.223H	--
7421326554	59.3901.233H	--
7421326558	59.3901.243H	--
7421346867	20.5520.250H	--
7421614025	09.3900.003.000	,69
7421618499	85.752.024.099	62

OE		
7423227102	61.1000.007.199	63
7423229803	61.1000.006.199	63
7424382986	20.1000.611.199	63
7424382989	20.1000.614.199	63
7424384060	19.1000.603.199	63
7424384062	19.1000.601.199	63
7424384063	13.1000.601.199	63
7424384076	13.1000.603.199	63
7424384079	58.1000.611.199	63
7424384743	58.1000.641.199	63
7424384744	58.1000.621.199	63
7424384748	19.1000.602.199	63
7424384871	19.1000.602.199	63
7424384872	58.1000.614.199	63
7424384873	09.1000.400.199	63
7424384925	58.1000.624.199	63
7424384933	58.1000.612.199	63
7424384935	58.1000.642.199	63
7424384936	58.1000.622.199	63
7424384963	58.1000.613.199	63
7424384969	58.1000.623.199	63
7424486090	20.1000.613.199	63
7424486092	20.1000.612.199	63
7424680566	59.1000.611.199	63
7424680570	59.1000.612.199	63
7424680572	59.1000.613.199	63
7424680575	59.1000.614.199	63
7424680579	59.1000.641.199	63
7424680584	59.1000.642.199	63
7424680595	59.1000.621.199	63
7424680600	59.1000.622.199	63
7424680606	59.1000.623.199	63
7424680610	59.1000.624.199	63
7478493162	59.1025.003.099	--
7482226023	59.5524.640.099	--
7482226025	59.5524.649.099	64,69
7482226027	59.5524.649.099	64
7482265705	59.5524.748.099	--
7482408450	19.1033.001.199	62
7482408451	19.1033.002.199	62
7484214269	61.1000.105.199	63
7484531138	59.1025.001.099	21,65,72
7484531168	59.1025.002.099	21,65,72
7485120820	61.3900.130H	62
Scania		
102088 / 2081428	55.3000.117	--
108832	11.3001.100	--
129429	20.2700.200H	44,85
1441529	59.2706.121	--
1441530	59.2706.101	--
1441533	59.2706.124	--
1441534	59.2706.104H	--
1448217	20.2480.210H	89
1451226	20.2480.216H	44,56,85,89
1451227	20.2480.211H	89
1485117	59.2706.203	--
1485118	59.2706.232	--
1505201	15.3731.470H	18,44,85
1505202	11.3730.210H	18,44,80,85
1505203	61.2708.842H	91
1522365	21.2706.100	--
1522366	21.2706.110	--
1522367	09.3200.360	--
1543451	51.2510.127H	32
1742422	09.3200.310H	--
1763444	51.1524.117	--
1767265	15.4001.740H	67
1805203	51.3732.326	44,85
1857128	59.2706.302	--
1880287	20.2710.121	85
1880288	20.2710.111H	85
1880289	59.2715.101.099	--
1880290	59.2715.102	--
1880295	20.2710.200H	44,85
1886454	40.2510.222H	32
1893487	51.3635.206	80
1893489	15.3802.840H	80
1893532	51.3731.326	44,85
1895048	51.3732.326	44,85
1915758	20.2700.260	--
1946640	15.2712.113F	85
2081428	55.3000.108H	--
2092223	55.2462.117	--
2092593	08.5752.024.099	45,46,62,63,69
2116023	56.1020.020.099	67
2116845	19.1019.013.099	67
2116846	19.1019.014.099	67
2116848	19.1019.313.099	67
2116849	19.1019.314.099	67
2118477	12.1020.003.099	67
2127721	55.2561.111.001	--
2239699	59.2706.005	--
22479890	11.2770.920	46
2248592	56.2660.002.099	31
2249381	19.1020.213.099	67
2249382	19.1020.613.099	67
2252649	58.2706.002.001	--
2252652	58.2706.104H	--
2332206	09.3200.320H	88

OE		
2382791	59.1005.003.099	67
2411114	59.2770.210.099	46
2434918	55.2561.111.001	--
2530656	09.2910.002.099	84,87
2530662	59.2910.004.001	86
2530663	59.2910.001.001	86
2537657	61.2910.009.002	--
2537709	11.2910.003.000	87
2537712	11.2910.011.002	87
2537714	19.2910.001.099	47,87
2537717	61.2910.011.002	--
2537719	11.2910.008.000	87
2537720	11.2910.012.002	87
2537722	61.2910.020.002	--
2537723	11.2910.017.000	--
2537726	61.2910.012.002	--
2541253	61.2910.005.001	87
2541254	11.2910.001.000	87
2541255	11.2910.002.000	87
2541259	61.2910.006.001	87
2541260	11.2910.006.000	87
2541261	11.2910.007.000	87
2541262	19.2910.002.099	47,87
2548189	15.2780.840	45,47,87
2556182	59.2782.120	--
2567224	59.2910.010.001	86
2567225	59.2910.017.001	86
2577310	09.3200.330	--
2599501	61.2910.019.002	--
2599528	61.2910.010.002	--
2599529	11.2910.014.000	--
2599530	11.2910.016.000	--
2723896	59.2770.310.099	46
2728569	59.2770.211.099	46
2729143	59.1041.001.099	47
2729156	59.1042.003.099	47
2729158	59.1042.001.099	47
2739165	11.2770.102	46
2739167	15.2771.840	46
2739168	15.2771.870	46
2760509	59.2910.012.001	--
2794079	08.2910.001.099	46,87
2911918	09.1041.002.099	47
2926677	15.2780.870	45
3070159	51.3000.002.001	79
3070160	61.3000.004.001	79
3139595	08.1024.124.099	47
437489	51.2540.148	--
437491	58.2481.012	--
639093	14.2530.100	--
639141	61.2530.110H	48
9006839	05.3308.100	--
SIAC		
166351394	40.1009.004.099	81
166352077	40.1009.002.099	81
166428555 - ALT	51.1009.048.099	--
620031733 - ALT	59.1017.003.099	82
620031734 - ALT	59.1017.004.099	82
620102328 - ALT	51.1009.017.099	81
620102331 - ALT	51.1009.013.001	--
620102332 - ALT	51.1009.009.099	81
620120281 - ALT	58.1017.005.099	82
620120282 - ALT	58.1017.006.099	82
620120283 - ALT	58.1017.011.099	82
620120284 - ALT	58.1017.012.099	82
620186052	09.3200.420H	30,81,83
SOLARIS		
0000-059-207	11.2770.102	46
0000-059-214	11.2770.202	46
0000-059-216	11.2770.302	46
0000-059-218	11.2770.402	46
0000-059-220	11.2770.920	46
0000-059-224	61.2770.210	46
0000-059-226	61.2770.211	46
0000-059-281	15.2780.840	45,47,87
0000-059-284	15.2780.870	45
0000-059-305	11.2780.910	45</

Vergleichsliste nach OE-Nummern Cross-reference-table

OE		
1905-501-001	58.2704.090	--
1905-501-020	58.2704.059	--
1905-501-040	20.2710.720	--
190550200	51.3732.326	44,85
1905-502-001	59.2770.210.099	46
190550300	51.3731.326	44,85
1905-503-001	59.2780.120.099	45
1905-503-100	20.2780.630	--
1905-504-000	56.2661.147	--
1905-505-000	11.3001.100	--
1905-506-010	58.2704.093	91
1905-506-100	51.2530.148H	--
1905-508-000	58.2704.048	91
1905-508-001	58.2704.071	--
1905-509-000	58.2704.070	91
1905-509-025	58.2704.051H	91
1905-510-000	59.3652.167H	--
1905-511-000	59.2640.110H	--
1905-530-080	40.2530.422H	48
1905731470	15.3731.470H	18,44,85
1905770210	11.3730.210H	18,44,80,85
1905-770-210	11.3730.210H	18,44,80,85
1970018000	20.2480.216H	44,56,85,89
1970-018-000	20.2480.216H	44,56,85,89
1970-019-000	20.2480.217H	44,56,85,89
5300-008-114	15.2561.600	--
5300-009-015	11.2780.510	--
Steyr		
16100770103	51.2890.117H	80
Tatra		
443332041000	51.3300.149	--
443332042000	59.3601.128H	68
443332051000	51.3635.206	80
443332052000	51.3636.206	80
443332058000	51.3635.216	--
443332059000	51.3636.216	--
443400151000	51.3300.147H	--
990115703000	15.3802.840H	80
990115704000	40.3605.203H	68
Temsa		
5053APA03Y	61.2910.004.001	87
5053APA0401Y	15.2780.840	45,47,87
5053APA0403Y	19.2910.001.099	47,87
5053APA04Y	59.2910.002.001	86
5053APA05Y	61.2910.003.001	87
5053APA06Y	59.2910.001.001	86
HD301144-02Y	19.2910.002.099	47,87
HD3011444Y	59.2910.004.001	86
HD301151	61.2910.006.001	87
HD301152	61.2910.005.001	87
MD301145Y	59.2910.010.001	86
Terex		
103724	51.1523.121H	--
105518	55.2020.171	--
27230912	59.5524.530H	79
48092012	15.3802.840H	80
5253100003	51.3640.127	--
5653634760	51.1523.111H	--
5653634770	51.1524.118	--
5653634775	51.2500.127H	68
5653634816	51.2500.147H	68
5653634822	51.2493.137H	--
5653634825	51.1009.017.099	81
5653634830	51.1009.089.099	--
5653634836	40.1009.001.000	81
5653634837	40.1009.002.000	81
VDL		
20510114	51.2530.148H	--
24012180000	51.2530.128H	--
28250087	55.2561.110	--
30014897	59.2770.210.099	46
30014898	59.2780.120.099	45
30016869	11.2780.910	45
30017252	15.2780.870	45
30017729	59.2710.402H	85
30017737	51.3732.326	44,85
30017741	15.3731.470H	18,44,85
30017752	11.3730.210H	18,44,80,85
30017839	55.2561.010	--
30017840	15.2561.640	--
30017844	15.2771.870	46
30017845	20.2780.630	--
30017846	15.2780.840	45,47,87
30017876	15.2780.840	45,47,87
30022423	51.3731.326	44,85
30032132	55.2561.110	--
30045213	11.2770.202	46
30045214	11.2770.302	46
30045215	11.2770.402	46
30102976	20.2710.630	--
30103263	11.2780.510	--
30103281	61.2770.210	46
30103282	61.2770.211	46
30103284	11.2780.920	45
30103285	11.2780.520	--
30103286	59.2780.150.001	45
30110912	09.2910.006.001	--



OE		
30120778	59.2712.111	44
30120779	59.2712.114	44
30120780	20.2480.222	--
30120781	20.2480.221	--
30121356	59.2910.024.001	--
30121358	20.2480.222	--
30121380	61.2910.027.001	--
30121381	61.2910.026.001	--
30127115	59.2706.006.001	--
30130954	51.3635.206	80
30130955	15.3802.840H	80
30130962	11.2910.001.000	87
30130963	11.2910.006.000	87
30130964	11.2910.003.000	87
30130965	11.2910.008.000	87
30130967	11.2910.012.000	--
30130970	61.2910.009.002	--
30130971	61.2910.019.002	--
30130972	19.2910.001.099	47,87
30130975	61.2910.010.002	--
30130976	61.2910.020.002	--
30130977	11.2910.016.000	--
30130978	11.2910.017.000	--
30130979	11.2910.014.000	--
30130981	19.2910.002.099	47,87
30130982	61.2910.011.002	--
30130983	61.2910.012.002	--
30130985	11.2910.002.000	87
30130986	11.2910.007.000	87
30139755	59.2910.027.001	--
30162330	55.3000.117	--
30162331	61.3000.002.001	79
30172295	59.2760.007.001	--
30172762	11.2770.040	--
30172776	61.2770.900.099	46
30184984	61.2910.006.001	87
30184985	61.2910.005.001	87
30207377	59.2910.500.001	--
30218618	20.2760.140	--
30218619	20.2760.150	--
30218620	51.3636.206	80
30218738	09.2910.003.099	46,87
30218739	08.3950.001.099	46,87
30226914	12.1018.002.099	84
30226915	19.1018.314.000	--
30243430	12.1018.001.099	84
31041266	08.2910.001.002	46,87
53707213480217	20.2480.217H	44,56,85,89
60000269	58.2601.010	--
60000270	09.3200.320H	88
H28250077	51.2500.167H	78
HJ24013370	51.3850.147H	78
J24013361200	09.3200.320H	88
P758200126	59.2710.401H	85
P759001645	20.2480.216H	44,56,85,89
P759001646	20.2480.217H	44,56,85,89
Viscon		
44152400300	09.2910.002.099	84,87
44176040317	59.2910.001.001	86
44176040318	59.2910.002.001	86
44176040321	59.2910.003.001	86
44176040322	59.2910.004.001	86
Volvo		
224798	15.2780.840	45,47,87
331121	20.2710.121	85
1096643	59.3601.128H	68
1581550	51.2500.127H	68
1581599	40.2500.222H	68
1581602	40.2500.422H	68
1581616	51.2500.147H	68
1594411	51.2500.147H	68
1594412	51.2500.147H	68
1594415	40.2500.422H	68
1599462	51.2520.127H	68
1697007	40.2520.422H	68
1697927	14.2530.100	--
1697928	61.2530.110H	48
2739166	11.2770.920	46
3090395	51.2520.127H	68
3090734	40.3605.204F	68
3090737	15.3702.470H	68
3090739	15.3712.410H	--
3091756	15.3702.470H	68
3091757	15.3712.410H	--
3092854	15.3702.470H	68
3093944	59.2715.101.099	--
3093945	59.2715.102	--
3098470	40.3640.422H	30,32
3126117	59.3602.128H	68
6795142	51.2520.177	--
16281990	51.1009.025.099	81
16315898	55.2020.177H	--
17452496	51.1009017099	81
20207881	59.3900.143H	--
20515454	20.2480.223	89
20523873	59.2710.410	--
20523877	59.2710.409	--
20526284	09.3200.320H	88
20526353	56.2660.127H	31



















OE		
20540638	20.2710.500	--
20549032	56.2660.147H	31
20548137	58.2700.010H	--
20564284	58.2704.086	91
20567670	15.2240.840H	72
20707812	59.5580.247H	65
20707874	59.3900.133H	--
20707881	59.3900.143H	--
20708110	20.3900.510H	69
20708230	20.3900.520H	69
20708303	59.3900.233H	--
20743983	59.3900.243H	--
20849837	59.5524.648.099	64,69
20854088	20.2480.211H	89
20854564	15.3702.470H	68
20854568	15.3712.410H	--
20854576	40.2520.422H	68
20854583	40.3605.204F	68
20862779	11.3900.200H	69
20862782	61.3900.100H	69
20862795	15.3900.840H	69
20862800	11.3910.200H	69
20862809	61.3911.110H	69
20862810	15.3911871H	69
20862812	08.5752.024.099	45,46,62,63,69
20862813	61.3911.120H	69
20862815	15.3911.872H	69
20866665	61.3900.110H	69
20866672	08.5752.024.099	45,46,62,63,69
20903722	58.3900.143H	69
20903723	58.3900.133H	69
20903727	58.3900.243H	69
20903732	58.3900.233H	69
20914934	58.3900.333H	69
20914938	58.3900.433H	69
20925244	08.3200.233H	45,46,84,87,88
20970652	51.3850.197H	78
20970794	61.3000.002.001	79
21020285	51.5524.930H	64,69,79
21070768	15.2242.870H	--
21083501	56.2600.147H	30
21083541	09.2070.101H	30,32,48,68,80,88
21150393	55.2561.110	--
21203313	59.3601.178H	68
21310517	51.2480.150H	--
21314080	55.3000.117	--
21320365	15.2242.870H	--
21320383	15.2240.840H	72
21326526	59.3900.233H	--
21326527	59.3900.243H	--
21386593	15.2712.113F	85
21462625	58.2704.065	--
21475603	59.3900.233H	--
21614025	09.3900.003.000	69
21618499	85.752.024.099	69
21879369	59.2910.001.001	86
21879404	59.2910.004.001	86
21885962	61.2910.005.001	87
21885963	61.2910.006.001	87
21885964	61.2910.003.001	87
21885965	61.2910.008.001	87
21894545	59.2910.002.001	86
21922258	59.2910.005.001	86
22026481	20.2710.605	45
22026977	59.2910.008.001	86
22033845	12.1018.001.099	84
22033846	12.1018.002.099	84
22033847	15.2780.840	45,47,87
22033849	19.1018.314.000	--
22038103	09.2910.002.099	84,87
22038110	08.3950.001.099	46,87
22117132	11.2910.003.000	87
22117135	11.2910.011.002	87
22117164	61.2910.009.002	--
22117179	19.2910.001.099	47,87
22117189	15.2780.840	45,47,87
22117205	61.2910.011.002	--
22117208	11.2910.008.000	87
22117209	11.2910.012.002	87
22117212	61.2910.020.002	--
22117213	11.2910.017.000	--
22117218	19.2910.002.099	47,87
22117220	61.2910.012.002	--
22117238	11.2910.001.000	87
22117239	11.2910.002.000	87
22117241		



Cross-reference-table Vergleichsliste nach OE-Nummern



















OE			OE			OE		
22210216	20.2480.221	--	70331122	20.2710.111H	85	2E0857514B	51.5894.212.199	--
22210899	58.2704.065	--	70331123	20.2480.217H	44,56,85,89	2E0857527	13.5890.120.099	59,61,75
22212132	58.2705.002	--	70331124	20.2480.216H	44,56,85,89	2E0857528	13.5890.220.099	59,61,75
22212554	09.2910.003.099	46,87	70331940	59.2762.322	44	2E0857587A	19.5890.011.099	59,61,75
22274292	59.2770.310.099	46	70331941	20.2710.620	44,45,89	2E0857587B	19.5891.011.099	59,75
22274295	59.2780.120.099	45	70332172	58.2704.078	--	2E0857588B	19.5891.012.099	59,75
22329661	15.2561.640	--	70348000	59.2715.101.099	--	2E0919473	08.5890.300.099	59,75
22360737	59.2910.015.001	86	70348001	59.2715.102	--	2E0919473A	08.5890.301.099	59,75
22360738	59.2910.016.001	86	70348002	20.2480.216H	44,56,85,89	2E0945981	08.5892.105.099	59,61,75
22366228	59.2910.500.001	--	70348003	20.2480.216H	44,56,85,89	2E0950050A	08.5892.003.099	59,61,75
22479675	11.2780.910	45	70348066	09.3200.220	88	2E0953049A	08.5892.001.099	59,75
22479729	20.2780.630	--	70352000	58.2705.003	91	2E0953049B	08.5892.004.099	59,75
22479736	11.2780.510	--	70352646	20.2480.210H	89	2E0953049C	08.5892.002.099	59,61,75
22479822	15.2780.870	45	70360528	20.2710.132D	--	2E0953050A	08.5892.004.099	59,75
22479887	11.2770.102	46	70360529	20.2480.222	--	2E0953050C	08.5892.003.099	59,61,75
22479899	11.2770.040	--	70360530	20.2710.200H	44,85	2E1857136	14.5890.100.099	59,61,75
22479901	11.2770.520H	--	70360531	58.2710.101	--	2E1857136A	14.5890.200.099	59,61,75
22479903	61.2770.901.099	46	70360533	11.3730.210H	18,44,80,85	2E1857501AJ	51.5891.111.199	58,74
22479907	11.2770.202	46	70360534	20.2710.142D	--	2E1857501AK	51.5892.111.199	58,74
22479912	15.2771.840	46	70360538	08.3491.325.000	--	2E1857501AL	51.5893.111.199	58,74
22479913	15.2771.870	46	70369682	51.3732.326	44,85	2E1857501E	51.5891.111.199	58,74
22480056	11.2770.302	46	73028283	59.2710.402H	85	2E1857501F	51.5891.113.199	58,74
22480060	11.2770.402	46	82356808	13.1043.001.000	71	2E1857501Q	51.5891.112.199	--
22480148	61.2770.210	46	82356810	19.1000.101.099	71	2E1857501R	51.5892.112.199	--
22480159	61.2770.900.099	46	82356824	19.1000.103.099	71	2E1857502AK	51.5891.211.199	58,74
22480393	09.2770.110H	--	82359213	13.1043.001.000	71	2E1857502AL	51.5892.211.199	58,74
22526136	59.2910.023.001	--	82359214	19.1000.102.099	71	2E1857502AM	51.5893.211.199	58,74
22526143	59.2910.027.001	--	82417041	40.5725.412H	33,72	2E1857502D	51.5892.211.199	58,74
22544279	59.2910.024.001	--	82417042	11.5721.001.099	33,72	2E1857502E	51.5891.211.199	58,74
22648216	61.2910.004.001	87	82417044	40.5735.403H	33,72	2E1857502F	51.5891.213.199	58,74
22836792	59.2910.007.001	86	82417045	11.5731.001.099	33,72	2E1857502P	51.5891.212.199	--
22838596	59.2760.007.001	--	82471688	61.5721.005.099	72	2E1857502Q	51.5892.212.199	--
22847902	51.3635.206	80	82471689	61.5731.001.099	--	2E1857516A	13.5890.110.199	59,61,75
22847915	11.3730.210H	18,44,80,85	82471690	61.5721.006.099	72	2E1857516B	13.5890.210.199	59,61,75
22847920	15.3802.840H	80	82472612	61.5721.004.099	33,72	2E1857587	15.5891.741H	59,75
23120356	58.2706.104H	--	84214269	61.1000.105.199	70	2E1857587A	15.5891.611H	59,75
23200690	51.7504.044.001	79	84531138	59.1025.001.099	21,65,72	2E1857587E	15.5891.721.099	59,61,75
23227102	61.1000.004.099	71	84531168	59.1025.002.099	21,65,72	2E1857588	15.5891.742H	59,75
23229803	61.1000.006.199	70	85104654	20.2700.260	--	2E1857588A	15.5891.612H	59,75
23238988	20.2710.121	85	85104656	20.2700.200H	44,85	2E1857588E	15.5891.722.099	59,61,75
23286290	20.7504.044.001	79	85120820	61.3900.130H	69	2E2857501C	51.5891.311.199	58,74
23286294	20.7504.003.001	79	592710409	59.2710.409	--	2E2857501D	51.5891.313.199	58,74
23329006	59.2910.006.001	86	703060536	15.2712.113F	85	2E2857501F	51.5891.312.199	--
23614948	20.2760.140	--	8350002289	09.2070.101H	30,32,48,68,80,88	2E2857501G	51.5892.312.199	--
23614972	20.2760.150	--	8350026023	09.3400.440	--	2E2857501N	51.5891.311.199	58,74
23655694	09.2710.200	--	8350035653	51.3731.326	44,85	2E2857502C	51.5891.411.199	74
23946968	59.2910.014.001	86	8350035654	51.3732.326	44,85	2E2857502D	51.5891.413.199	58,74
23946969	59.2910.013.001	86	8350035655	09.3200.220	88	2E2857502F	51.5891.412.199	--
24015370	19.1000.121.099	71	8350042502	59.2710.401H	85	2E2857502G	51.5892.412.199	--
24015373	19.1000.122.099	71	8350045482	20.2700.240	--	2E2857502N	51.5891.411.199	74
24018790	51.3000.002.001	--	8350045484	20.2700.230	--	2E3857501D	51.5892.111.199	58,74
24018822	61.3000.004.010	79	8350046432	20.2480.217H	44,56,85,89	2E3857501E	51.5893.111.199	58,74
24382986	20.1000.611.199	70	8350046433	20.2710.200H	44,85	2E3857501F	51.5892.113.199	58,74
24382989	20.1000.614.199	70	8350046555	11.3730.210H	18,44,80,85	2E3857501G	51.5893.113.199	58,74
24384060	19.1000.603.199	70	8350046557	15.2712.114	44,85	2E3857501H	51.5893.112.199	--
24384062	19.1000.601.199	70	8350046970	20.2710.111H	85	2E3857501J	51.5891.114.199	--
24384063	13.1000.601.199	70	8350046971	20.2480.216H	44,56,85,89	2E3857502E	51.5893.211.199	58,74
24384076	13.1000.603.199	70	8690002311	40.3005.222	--	2E3857502F	51.5892.213.199	58,74
24384079	58.1000.611.199	70	8350046556	15.2711.114	44,85	2E3857502G	51.5893.213.199	58,74
24384743	58.1000.641.199	70	589990057800	51.3410.147H	30	2E3857502J	51.5891.411.199	--
24384744	58.1000.621.199	70	589990057960	51.2540.148	--	2E3857502K	51.5891.214.199	--
24384748	19.1000.602.199	70	5899900579601	40.2540.422H	48	2E4857501AD	51.5892.311.199	58,74
24384871	13.1000.602.199	70	8706271900014	59.2715.101.099	--	2E4857501D	51.5892.311.199	58,74
24384872	58.1000.614.199	70	8706271900015	59.2715.102	--	2E4857501F	51.5892.313.199	58,74
24384873	09.1000.400.199	70	8706271900018	20.2480.217H	44,56,85,89	2E4857501K	51.5891.314.199	--
24384925	58.1000.624.199	70	8706271900020	20.2710.111H	85	2E4857502E	51.5892.411.199	58,74
24384933	58.1000.612.199	70	8706271900021	09.3200.220	88	2E4857502G	51.5892.413.199	58,74
24384935	58.1000.642.199	70	8706271900030	15.3731.470H	18,44,85	2E4857502L	51.5891.414.199	--
24384936	58.1000.622.199	70	8706271900031	59.2705.000	--	2E4857513B	51.5895.312.199	--
24384963	58.1000.613.199	70	8706271900052	11.3730.210H	18,44,80,85	2E4857514B	51.5895.412.199	--
24384969	58.1000.623.199	70	8706271900055	20.2480.210H	89	7C0857521D	19.1013.011.099	77
24486090	20.1000.613.199	70	8706271900058	58.2704.059	--	7C0857521G	19.1013.011.099	77
24486092	20.1000.612.199	70	8706271900059	51.3731.326	44,85	7C0857522A	19.1013.012.099	77
24680566	59.1000.611.199	70	8706271900060	51.3732.326	44,85	7C0857522F	19.1013.012.099	77
24680570	59.1000.612.199	70	8706331900007	56.3491.110H	57,73			
24680572	59.1000.613.199	70	8706331900008	56.3492.110H	57,73			
24680575	59.1000.614.199	70	7033112370348000	20.2480.217H	44,56,85,89			
24680579	59.1000.641.199	70	1195934 / 3090396	51.2520.147H	68			
24680584	59.1000.642.199	70	1594902 / 1621353	51.2520.147H	68			
24680595	59.1000.621.199	70	161 00 77 0005	51.3200.147H	30			
24680600	59.1000.622.199	70	21885961 / 22117455	61.2910.002.001	87			
24680606	59.1000.623.199	70	22342703 / 8350055851	20.2710.630	--			
24680610	59.1000.624.199	70	22488075 / 22117241	08.2910.001.002	46,87			
52510003	56.2630.127	--	5.899.90.057.81	40.3640.422H	30,32			
70309620	58.2705.001H	91	5.899.90.058.03	51.2540.128	--			
70309627	51.3731.326	44,85						
70309630	58.2704.059	--						
70310107	56.2630.127	--						
70310110	11.1523.212	--						
70328278	59.2710.401H	85						
70328289	59.2710.406	85						
70328290	20.2710.121	85						
70328291	59.2706.104H	--						
70328294	58.2704.070	91						

DAF



















373	II [e1] 02★0423 II (E1) 010423	 II		Ø 28 mm
------------	-----------------------------------	--	---	---------

MEKRA LANG Group	Beschreibung description descripção descriziune benjämning popis omrcaavre čretilik leirats opis						mm	OE
	61.3730.324H	    	384 x 205 x 120	1425 104 ♦ 1610 186				
	15.3731.470H	  	369 x 190 x 42	1425 109 ♦ 1610 190				
	11.3730.210H		367 x 187 x 60	1425 113				
	61.3730.326H	    	384 x 205 x 120	1425 105 ♦ 1610 184				
	15.3731.470H	  	369 x 190 x 42	1425 109 ♦ 1610 190				
	11.3730.210H		367 x 187 x 60	1425 113				

386 386-1	IV [e1] 02★0424 IV (E1) 010424 IV [e1] 03★0023	 IV		Ø 28 mm
----------------------------	--	--	---	---------

MEKRA LANG Group	Beschreibung description descripção descriziune benjämning popis omrcaavre čretilik leirats opis						mm	OE
	61.3860.214H	    	219 x 170 x 120	1425 108 ♦ 1610 187				
	15.3861.114H	  	203 x 154 x 36	1425 111 ♦ 1610 191				
	11.3860.500H		203 x 154 x 60	1425 114				
	61.3865.124H	    	219 x 170 x 120	1610 189				
	15.3862.174H	  	203 x 154 x 36	1610 182				
	11.3860.500H		203 x 154 x 60	1425 114				

906	IV [e1] 03★0014	 IV		Ø 28 mm
------------	-----------------	--	---	---------

MEKRA LANG Group	Beschreibung description descripção descriziune benjämning popis omrcaavre čretilik leirats opis						mm	OE
	61.9065.114H	   	209 x 218 x 136	1670 877				
	15.9060.870H	  	204 x 195 x 58	1670 878				
	11.9060.100H		202 x 194 x 55	1670 888				
	56.9065.110	    	209 x 218 x 136					
	15.9060.870H	  	204 x 195 x 58	1670 878				
	11.9060.100H		202 x 194 x 55	1670 888				
	61.3860.100		210 x 9ø					

65 CF, 75 CF,
85 CF, 95 XF
alternativ 75 / 85 / 95

03/00 - 04/06
09/92 →



DAF

348	II 03★0184 II 021022			Ø 22 mm
	Beschreibung description description description benamning popis özellik leirás opis			
61.3481.149H		1	395 x 205 x 145	1805 714
15.3480.840H				

XF 95, XF 105, XF 106
CF 65/75/85
JOHN DEERE

01/06
05/06
10/11



XF 95, XF 105, XF 106

02/13

DAF

570	II e1 03★0007 II E1 02 1251			Ø 40 mm
	Beschreibung description descripção descrizione description benamning pops omrcauwe čreilnik leiraks opis		mm	OE
61.5700.210H		411 x 228 x 140	1692 557	
61.5700.310.099		411 x 228 x 140	1812 862 + 1689 348	
15.5701.840H		363 x 177 x 25	1685 330 AL 20 31 51 (John Deere)	
11.5700.100H		411 x 228 x 110	1644 325	
09.5700.001.099		250 x 6 ø		

571 574	IV e1 03★0008 IV E1 02 1252 IV E1 02 1253			Ø 40 mm
	Beschreibung description descripção descrizione description benamning pops omrcauwe čreilnik leiraks opis		mm	OE
EURO 5				
61.5710.210H		239 x 221 x 140	1692 556	
61.5710.310.099		239 x 221 x 140	1817 860 + 1689 347	
15.5711.870H		207 x 161 x 35	1685 331	
11.5710.110H		239 x 221 x 118	1644 326 + 1659249	
09.5700.002.099		250 x 6 ø	1812 865	
EURO 6				
61.5710.310.099		239 x 221 x 140	1817 860 + 1689 347	
15.5711.870H		207 x 161 x 35	1685 331	
11.5710.110H		239 x 221 x 118	1644 326 + 1659249	
61.5740.001.099		245 x 243 x 140	1940 341	
19.5740.311.099		211 x 192 x 40	1940 342	
12.5740.002.099		245 x 240 x 118	1882 113	

XF 95, XF 105, XF 106
CF 65/75/85

11/09
11/09



559	VI E1 021039 VI e1 03★0196			INTEGR.
	Beschreibung description descripção descrizione description benamning pops omrcauwe čreilnik leiraks opis		mm	OE
XF				
59.5595.235H		411 x 375 x 285	1684 042 + 1816 912	
59.5595.236		411 x 375 x 285	1684 043 + 1816 913	
XF				
59.5595.331H		1007 x 320 x 220	1684 046 + 1816 914	
59.5595.332		1007 x 320 x 220	1684 047 + 1816 915	
CF				
59.5595.131H		437 x 433 x 383	1684 030 + 1816 902	
59.5595.132H		437 x 433 x 383	1684 031 + 1816 903	
61.5590.001.099		256 x 165 x 82	1830 338	
20.5521.100H		110 x 53 x 51	1698 180	

DAF

570 A		ALU		Ø 40 mm			
MEKRA LANG Group		Beschreibung description descripção descrizione benamning popis opisane özelliik leirás opis		mm		OE	
58.5701.104.099		818 x 40 ø	1685 324	1812 867	XF	EURO 5	
58.5700.001.099		818 x 40 ø	1685 325	1830 562	XF	EURO 6	
58.5700.003.099		818 x 40 ø	1940334		CF		
58.5700.004.099		818 x 40 ø	1940335		CF		
58.5713.114.099		920 x 40 ø	1788 972	1812 859	XF	EURO 5	
58.5710.001.099		920 x 40 ø	1788 487	1818 353	XF	EURO 6	
20.5700.410H		145 x 98 x 68	1644 324		XF	EURO 5	
20.5700.420H		145 x 98 x 68	1644 323		XF	EURO 6	
12.5700.001.099		304 x 113 x 82	1882 126		XF	EURO 5	
12.5700.002.099		205 x 78 x 45	1882 111		XF	EURO 6	
12.5700.003.099		304 x 113 x 82	1882 127		CF		
12.5700.004.099		205 x 78 x 45	1882 112		CF		



XF 95, XF 105, XF 106
CF 65/75/85
01/06
05/06

552 552-1		V e1 02★0742 V VI e1 03★0033 V VI (E) 020894		Truck ABS		OE	
MEKRA LANG Group		Beschreibung description descripção descrizione benamning popis opisane özelliik leirás opis		mm		OE	
59.5520.230H		319 x 187 x 50	1669 573		XF		
59.5520.130H		319 x 187 x 50			CF		



1005		V e1 04★1336 V (E) 041336		Truck ABS		OE	
MEKRA LANG Group		Beschreibung description descripção descrizione benamning popis opisane özelliik leirás opis		mm		OE	
59.1005.001.099		326 x 202 x 214	1949 304		CF		
59.1005.002.099		326 x 202 x 214	1949 305		XF		

New Regulation ECE R46/04



1025		V e1 04★1345		Truck ABS		OE	
MEKRA LANG Group		Beschreibung description descripção descrizione benamning popis opisane özelliik leirás opis		mm		OE	
59.1025.001.099		315 x 179 x 220	1709 390		LF		
59.1025.002.099		315 x 179 x 220	1709 389		LF		

LF 45/55

New Regulation ECE R46/04



*XD / XF / XG / XG+
New Generation*

10/2020



DAF

1027	II (E1) 041619			INTEGR.
	IV (E1) 041620			

	Beschreibung description description descrizione descripção benámenning popis opis opis		mm	
--	---	--	----	--

LHD	59.1027.001.099		1014 x 397 x 200	2248 157 + 2424 898			
	59.1027.002.099		1014 x 414 x 258	2248 158 + 2424 899			
	RHD	59.1027.003.099		1014 x 414 x 258	2248 175 + 2352 946 + 2424 900		
		59.1027.004.099		1014 x 397 x 200	2248 176 + 2424 901		
a	12.1027.005.099		für pour main mirror		1	701 x 248 x 154	2248 166
	12.1027.107.099		für pour main mirror		2	701 x 248 x 154	2248 172
	12.1027.207.099		für pour main mirror		3	701 x 248 x 154	2298 826
	12.1027.006.099		für pour main mirror		4	701 x 248 x 154	2248 167
	12.1027.108.099		für pour main mirror		5	701 x 248 x 154	2248 173
	12.1027.208.099		für pour main mirror		6	701 x 248 x 154	2298 827
b	12.1027.001.099		für pour upper foot		7	205 x 103 x 98	2248 164
	12.1027.002.099		für pour upper foot		8	205 x 103 x 98	2248 165
c	12.1027.103.099		für pour lower foot		9	266 x 177 x 114	2248 160 + 2424 902
	12.1027.203.099		für pour lower foot		10	266 x 177 x 114	2298 758 + 2424 904
	12.1027.104.099		für pour lower foot		11	266 x 177 x 114	2248 161 + 2424 903
	12.1027.204.099		für pour lower foot		12	266 x 177 x 114	2298 759 + 2424 905
d	19.1027.011.099				13	384 x 200 x 42	2306 590
	19.1027.012.099				14	384 x 200 x 42	2306 591
	19.1027.311.099				15	209 x 210 x 52	2306 592
	19.1027.312.099				16	209 x 210 x 52	2306 593
	12.1027.015.099		für pour neck		17	176 x 164 x 79	2248 168
	12.1027.016.099		für pour neck		18	176 x 164 x 79	2248 169
	61.1029.224.099		für pour		19	130 x 125 x 50	2306 586
	61.1024.224.099		für pour		20	130 x 125 x 50	2306 587

a



b



c



d

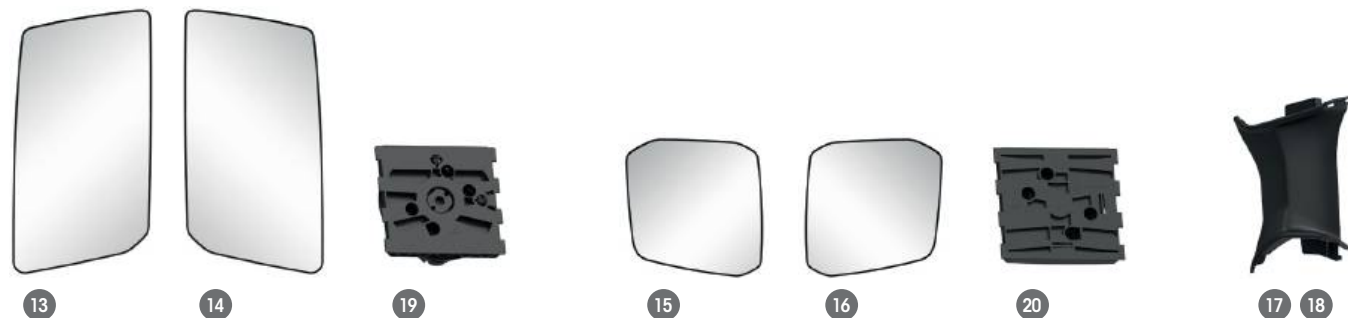

black

DAF

559	VI (E1) 021039			INTEGR.
	VI (e1) 03★0196			
	Beschreibung description description description benämning poris описание dzeliks leigās opis		OE	
59.5590.013.099		450 x 491 x 217	2248 178 + 2346 204 + 2415 378	
59.5590.014.099		450 x 491 x 217	2248 179 + 2346 205 + 2415 379	
12.5590.009.099	1	209 x 128 x 70	2248 184	

*XD/ XF / XG / XG+
New Generation*

10/2020 →

DAF



black

1005	V (e1) 04★1336			
	V (E1) 041336			
	Beschreibung description description description benämning poris описание dzeliks leigās opis		OE	
59.1005.011.099		330 x 233 x 205	2248 159	
12.1005.001.099	2	121 x 78 x 52	2248 174	

*XD/ XF / XG / XG+
New Generation*

10/2020 →



black

DAF

1000

NEW

II (E) 021108
IV (E) 021109



ABS

INTEGR.



Beschreibung
description
description
description
description
benamning
Pops
omircauwe
bireilik
letrās
opis



OE

59.1000.611.199		kurz short	890 x 439 x 180	2363198	
59.1000.612.199		kurz short	890 x 441 x 180	2363200	
59.1000.613.199		kurz short	890 x 439 x 180	2363202	
59.1000.614.199		kurz short	890 x 441 x 180	2363204	
59.1000.641.199		mittel medium	890 x 490 x 180		
59.1000.642.199		mittel medium	890 x 483 x 180	2363207	
59.1000.621.199		lang long	890 x 539 x 180	2363212	
59.1000.622.199		lang long	890 x 530 x 180	2363214	
59.1000.623.199		lang long	890 x 539 x 180	2363216	
59.1000.624.199		lang long	890 x 530 x 180	2363218	
58.1000.611.199		kurz short	1	890 x 439 x 28 ø	2436404
58.1000.612.199		kurz short	1	890 x 441 x 28 ø	2436405
58.1000.613.199		kurz short	1	890 x 439 x 28 ø	2436406
58.1000.614.199		kurz short	1	890 x 441 x 28 ø	2436407
58.1000.641.199		mittel medium	1	890 x 490 x 28 ø	2436412
58.1000.642.199		mittel medium	1	890 x 483 x 28 ø	2436413
58.1000.621.199		lang long	1	890 x 539 x 28 ø	2436408
58.1000.622.199		lang long	1	890 x 530 x 28 ø	2436409
58.1000.623.199		lang long	1	890 x 539 x 28 ø	2436410
58.1000.624.199		lang long	1	890 x 530 x 28 ø	2436411
61.1000.105.199		KIT	9	81 x 76 x 45	2430046
61.1000.006.199		KIT	7	130 x 127 x 65	2430047
61.1000.007.199		KIT	8	130 x 127 x 65	2430048
13.1000.601.199			3	393 x 210 x 46	2430049
13.1000.602.199			3	393 x 210 x 46	2430050
13.1000.603.199			5	210 x 208 x 54	2430051
19.1000.601.199		24 V 1200	2	387 x 205 x 41	2430052
19.1000.602.199		24 V 1200	2	387 x 205 x 41	2430053
19.1000.603.199		24 V 300	4	205 x 205 x 55	2430054
20.1000.611.199		für for pour	6	519 x 160 x 100	2430055
20.1000.612.199		für for pour	6	519 x 160 x 100	2430056
20.1000.613.199		für for pour t. sensor	6	519 x 160 x 100	2430057
20.1000.614.199		für for pour t. sensor	6	519 x 160 x 100	2430058
09.1000.400.199		temperature sensor		215	

DAF XB/XBC/XB
Electric

01/2024

DAF

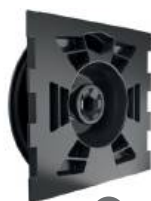
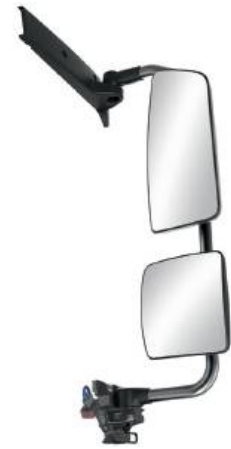

FORD

1049	NEW	II E9 03★6909			INTEGR.
		II E9 03★6950			

	Beschreibung		OE
	description		
	descripção		
	descriptione		
	benamining		
	popis		
	opis		

Part No.	Icons	Dimensions	Part No.	Quantity
59.1049.011.099		380 x 385 x 275	BK31-17683-JJ5J6A	1
59.1049.012.099		380 x 385 x 275	BK31-17682-JJ5J6A	
59.1049.013.099		380 x 385 x 275	1911158 ♦ BK31-17683-NA5JA	
59.1049.014.099		380 x 385 x 275	1911141 ♦ BK31-17682-NA5JA	
19.1049.001.099		223 x 180 x 20	1823986	1
19.1049.002.099		223 x 180 x 20	1823995	3
19.1049.003.099		223 x 180 x 20	1823994	1
19.1049.004.099		223 x 180 x 20	1823985	3
19.1049.005.099		175 x 92 x 20	1855103	2
19.1049.006.099		175 x 92 x 20	1855102	4
12.1049.001.099		355 x 265 x 65	1823809	
12.1049.002.099		355 x 265 x 65	1823808	
08.1049.001.099		150 x 95 x 60	2085655	5
08.1049.002.099		150 x 95 x 60	2043755	5

Transit



1



1

Anschlusskabel ab Bj. 2013-2019, 8-Polig
Connection cable from year 2013-2019, 8-pin

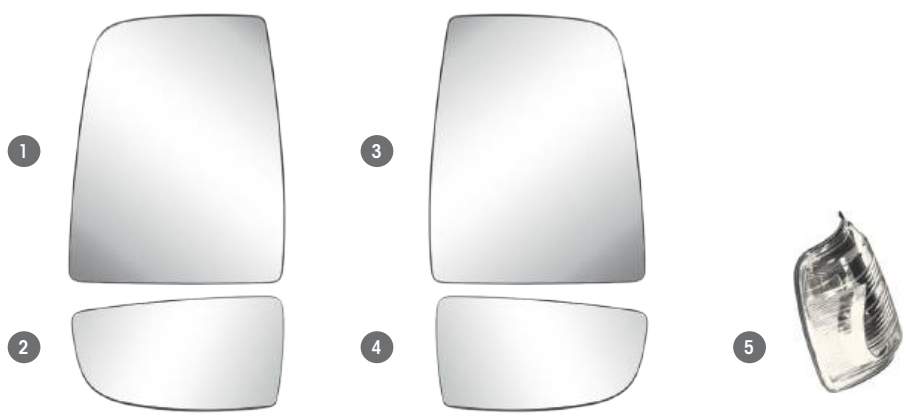

IVECO

Stralis
Trakker
Eurocargo
Tector

04/06
04/06
04/06
04/06



IVECO

1008		II e3 03★1034 IV e3 03★1036		Truck II+IV	ABS	INTEGR.
MEKRA LANG Group		Beschreibung description descripção descripziõe benamning popis omircaune üzellik teirás opis		mm		OE
59.1008.005.099		24 V	799 x 370 x 272	504 150 526 + 504 369 910 580 133 4614		
59.1008.006.099		24 V	799 x 370 x 272	504 150 527 + 504 369 961 580 133 4610		
59.1008.045H*		24 V	799 x 370 x 272	504 150 532		
59.1008.046H*		24 V	799 x 370 x 272	504 150 533		
59.1008.011.099		24 V	799 x 424 x 287	504 150 538 + 504 370 048 580 133 6285		
59.1008.012.099		24 V	799 x 424 x 287	504 150 539 + 504 370 055 580 133 6298		
59.1008.051H*		24 V	799 x 424 x 287	504 150 544		
59.1008.052H*		24 V	799 x 424 x 287	504 150 545		
59.1008.017.099		24 V	811 x 520 x 304	504 150 551 + 504 369 979 580 134 1206		
59.1008.018.099		24 V	811 x 520 x 304	504 150 552 + 504 369 995 580 134 1207		
59.1008.057H*		24 V	811 x 520 x 304	504 150 557		
59.1008.058H*		24 V	811 x 520 x 304	504 150 558		
19.1008.041.099		1200 24 V	371 x 181 x 15	504 197 878		
19.1008.311.099		300 24 V	192 x 206 x 20	504 197 879		

* only available in UK/IRL



1008		V e3 03★1031		Truck V	ABS	
MEKRA LANG Group		Beschreibung description descripção descripziõe benamning popis omircaune üzellik teirás opis		mm		OE
56.1008.002.099		300 24 V	270 x 230 x 60	504 168 236		
56.1008.003.099*		300 24 V	270 x 230 x 60	504 168 237		
56.1008.004.099*		300 24 V	270 x 230 x 60	504 168 238		
11.1008.001.099		für pour	210 x 205 x 100	504 168 244		

* only available in UK/IRL

IVECO

1008	VI e3 03★1042			INTEGR.
	Beschreibung description descripção descrizione benámenning popis onycauwe őzeilijk leírás opis		OE	
55.1008.002.099		315 x 240 x 60	504 224 428	
55.1008.003.099*		315 x 240 x 60	504 224 429	
55.1008.004.099*		315 x 240 x 60	504 224 430	

* only available in UK/IRL

Stralis
Trakker
Eurocargo
Tector



IVECO

04/06 - 2019
04/06
04/06
04/06

279	II e4 04★11854 IV e4 04★11853 V e4 04★11687 V e4 04★11688			INTEGR.
	Beschreibung description descripção descrizione benámenning popis onycauwe őzeilijk leírás opis		OE	
19.2790.011.099		399 x 222	500 086 749	
19.2790.012.099		399 x 222	500 086 750	
19.2790.031.099		223 x 218	500 086 753	
19.2790.032.099		223 x 218	500 086 754	
11.2790.001.099		640 x 240 x 108	580 249 8968	
11.2790.002.099		640 x 240 x 108	580 249 8969	

S-Way, T-Way



2020

MAN

M 90, F 90

03/00



320	II [e1] 02★14054 II [e1] 02★14053 II (E1) 0114053	II		Ø 18-30 mm
	Beschreibung description descripção descripzione benamning popis özellik leirás opis		OE	
51.3200.147H		380 x 190 x 100	81.63730-6193	
40.3200.422H		366 x 176 x 3	81.63733-0036	
09.3200.420H		42 x 42 x 54 [2000]	88.25505-0024	

MAN

M 90, F 90

08/88 - 09/94



340 341	II [e1] 02★14098 II (E1) 0114098	II		① Ø 14-20 mm ② Ø 20-30 mm
	Beschreibung description descripção descripzione benamning popis özellik leirás opis		OE	
51.3410.127H		377 x 189 x 65	81.63730-6233 + 81.63730-6220	
51.3412.120H		377 x 189 x 65	81.63730-6420	
40.3640.222H		363 x 175 x 3	81.63733-0025 + 81.63733-0030 81.63733-0060	
51.3410.147H		377 x 189 x 65	81.63730-6234 + 81.63730-6221 81.62730-6221	
51.3410.140		377 x 189 x 65		
40.3640.422H		363 x 175 x 3	81.63733-0064 + 81.63733-6003 81.63730-0032 + 81.63730-6003 81.63730-6202 + 85.20000-9601	
10.6121.100		340 x 159		
09.2000.301H		2000 x 9ø	83.25402-6010	
51.3400.147H		377 x 189 x 65	88.63730-6041 + 85.63730-6015 81.63730-6016	
40.3640.422H		363 x 175 x 3	81.63733-0064 + 81.63733-6003 81.63730-0032 + 81.63730-6003 81.63730-6202 + 85.20000-9601	
09.3400.420		42 x 42 x 54 [2000]		

M 90, F 90

07/88



260	IV [e1] 02★11001	IV		Ø 14-20 mm
	Beschreibung description descripção descripzione benamning popis özellik leirás opis		OE	
56.2600.127H		205 x 158 x 70	81.63730-6206	
40.2605.204H		190 x 143 x 3	81.63733-0042	
56.2600.147H		205 x 158 x 70		
40.2605.204H		190 x 143 x 3	81.63733-0042	
10.6321.100		186 x 130		
09.2070.101H		2070 x 9ø	81.25432-0149	

MAN

266 266-1	IV V 02★11008 IV V 0111008 IV V 0211008			① Ø 14-20 mm ② Ø 20-30 mm
----------------------------	--	--	--	------------------------------

		Beschreibung description descripção descrizione description benamning popis описание skaidra opis		mm	OE
56.2660.127H	<td>214 x 164 x 55</td> <td>81.63730-6421</td>	214 x 164 x 55	81.63730-6421		
40.2665.204H					

MAN / VW G 90 (6-9 t) 10/75 - 07/88



MAN

251	II e1 01★14050	Truck II	ABS	Ø 14-20 mm
MEKRA LANG Group		mm		OE
Beschreibung description description descrição descripzione benämning pops описанье özelliik leirás opis				
51.2510.127H		318 x 186 x 26	81.63730-6167 + 81.63730-6127	
40.2510.222H		308 x 176 x 3	81.63733-0032	
51.2510.137H		318 x 186 x 26		
40.2510.322H		308 x 176 x 3		
10.6211.100		282 x 162		
09.2070.101H		2070 x 9ø	81.25432-0149	
51.2510.147H		318 x 186 x 26	81.63730-6128 + 81.63730-6148	
40.2510.422H		308 x 176 x 3		
10.6221.100		282 x 162		
09.2070.101H		2070 x 9ø	81.25432-0149	

10/75 - 07/88

F8, F9



364	II e1 02★14082 II (E1) 0114082	Truck II	ABS	Ø 14-20 mm
MEKRA LANG Group		mm		OE
Beschreibung description description descrição descripzione benämning pops описанье özelliik leirás opis				
51.3640.127H		376 x 187 x 28	81.63730-6108 + 81.63730-6126 81.63730-6149 + 81.63730-6147 81.63730-6148 + 81.63730-6194	
40.3640.222H		363 x 175 x 3	81.63733-0025 + 81.63733-0030 81.63733-0060	
51.3640.137H		376 x 187 x 28		
40.3640.322H		363 x 175 x 3		
10.6111.100		340 x 159		
09.2070.101H		2070 x 9ø	81.25432-0149	
51.3640.147H		376 x 187 x 28	81.63730-6151 + 81.63730-6001	
40.3640.422H		363 x 175 x 3	81.63733-0064 + 81.63733-6003 81.63730-0032 + 81.63730-6003 81.63730-6202 + 85.20000-9601	
10.6121.100		340 x 159		
09.2070.101H		2070 x 9ø	81.25432-0149	

MAN

572	II 03★0031 II 020918		Ø (18) / 22 / 28 mm
	Beschreibung description descripção descriptione benamning Popis описанье breiðlik leirás opis		OE
51.5720.120H		426 x 200 x 135	85.63730-6030
40.5725.212H		412 x 188 x 3	81.63733-0101
51.5720.140H		426 x 200 x 135	85.63730-6033
40.5725.412H		412 x 188 x 3	81.63733-0103
51.5721.160H		426 x 200 x 135	85.63730-6035
51.5722.160H		426 x 200 x 135	85.63730-6036
40.5725.412H		412 x 188 x 3	81.63733-0103
61.5721.004.099		78 x 69 x 38	
11.5721.001.099		426 x 199 x 36	
11.3860.700		100 x 22 Ø → 18 Ø	

06/2005 →
06/2005 →

TGL, TGM (TGA)
L 2000, M 2000



MAN

573	IV 03★0032 IV 020917		Ø (18) / 22 / 28 mm
	Beschreibung description descripção descriptione benamning Popis описанье breiðlik leirás opis		OE
56.5730.120H		202 x 198 x 126	85.63730-6037
40.5735.203H		190 x 184 x 3	81.63733-0104
56.5730.140H		202 x 198 x 126	85.63730-6039
40.5735.403H		190 x 184 x 3	81.63733-0106
61.5721.004.099		78 x 69 x 38	
11.5731.001.099		202 x 198 x 27	
11.3860.700		100 x 22 Ø → 18 Ø	



579	V 03★0109 V 021179		
	Beschreibung description descripção descriptione benamning Popis описанье breiðlik leirás opis		OE
56.5790.003.099		303 x 163 x 88	81.63730-6734 + 81.63730-6574
15.5791.570.099		303 x 163 x 55	81.63733-6078
56.5790.004.099		303 x 163 x 88	81.63730-6733 + 81.63730-6573
15.5791.470H		303 x 163 x 55	81.63733-6074



MAN

373

II  02★0524II  010524

ABS

Ø (18) / 22 mm

MEKRA
LANG GroupBeschreibung
description
descripción
descricao
description
benamning
popis
omicaune
üzellik
leiras
opis

OE

51.3735.124H		384 x 205 x 120	81.63730-6315 * 81.63730-6365 81.63730-6361
51.3736.124H		384 x 205 x 120	81.63730-6304 * 81.63730-6366 81.63730-6362 * 81.63732-0046
51.3731.325		384 x 205 x 120	
51.3732.325		384 x 205 x 120	
51.3735.126H		384 x 205 x 120	81.63730-6316 * 81.63730-6367 81.63730-6363 * 81.63732-0051
51.3736.126H		384 x 205 x 120	81.63730-6305 * 81.63730-6368 81.63730-6364 * 81.63732-0047
15.3731.373		369 x 190 x 42	
15.3731.074H		369 x 190 x 42	81.63733-0067 * 81.63733-0075 81.63730-0067
11.3730.310H		367 x 187 x 60	
11.3860.700		100 x 22 ø -> 18 ø	

386

IV  02★0424IV  010424

ABS

Ø (18) / 22 mm









MEKRA
LANG GroupBeschreibung
description
descripción
descricao
description
benamning
popis
omicaune
üzellik
leiras
opis







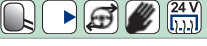
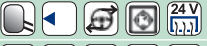

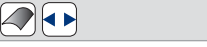
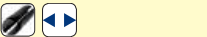



OE

56.3860.112H		219 x 170 x 120	81.63730-6306
56.3860.114H		219 x 170 x 120	81.63730-6307 * 81.63732-0050
56.3861.116H		219 x 170 x 120	81.63730-6317 * 81.63732-0049
56.3862.116H		219 x 170 x 120	81.63730-6308 * 81.63730-6328 81.63732-0048
11.3860.300H		203 x 154 x 60	
11.3860.700		100 x 22 ø -> 18 ø	

F 2000, L 2000
M 200009/94 - 03/00
09/97 - 03/00

MAN

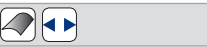
380-1		II  03★0022 II  020905		 II		Ø (18) / 22 mm
		Beschreibung description descripção descrizione benámening Popis оригинале leirás opis				OE
51.3801.148H		384 x 205 x 120	82.63730-6015			
51.3802.148H		384 x 205 x 120	82.63730-6016			
51.3801.168H		384 x 205 x 120	82.63730-6017			
51.3802.168H		384 x 205 x 120	82.63730-6018			
15.3802.840H		368 x 189 x 40	81.63733-0095			
11.3800.300H		374 x 196 x 40	81.63732-0044			
11.3860.700		100 x 22 ø -> 18 ø				

381-1		IV  03★0023 IV  021248		 IV		Ø (18) / 22 mm
		Beschreibung description descripção descrizione benámening Popis оригинале leirás opis				OE
56.3812.128H		219 x 170 x 120	82.63730-6022 * 82.63730-6021			
56.3812.148H		219 x 170 x 120	82.63730-6024 * 82.63730-6023			
56.3811.168H		219 x 170 x 120	82.63730-6025			
56.3812.168H		219 x 170 x 120	82.63730-6026			
11.3810.340		209 x 160 x 40	81.63732-0078 * 81.63732-0045			
11.3860.700		100 x 22 ø -> 18 ø				

New Regulation
F 2000, L 2000
M 2000
2003/97/ECE
2007/38/ECE
09/94 - 03/00
09/97 - 03/00



MAN



MAN

F2000
TGA
TGL
TGM

09/94 - 03/00
03/00 →
2005 - 11/14
04/06 - 11/14



579	V 03★0109 V 021179		
	Beschreibung description descripción descripção descripzione benámenning popis opniscawe úzeľník opis	mm	OE
56.5790.003.099		303 x 163 x 88	81.63730-6734 * 81.63730-6574
15.5791.570.099		303 x 163 x 55	81.63733-6078
56.5790.004.099		303 x 163 x 88	81.63730-6733* 81.63730-6573
15.5791.470H		303 x 163 x 55	81.63733-6074

TGA
TGL
TGM

03/00 - 11/06
2005 - 11/06
04/06 - 11/06



392	II 02★0646 II 010646		Ø 28 mm
	Beschreibung description descripción descripção descripzione benámenning popis opniscawe úzeľník opis	mm	OE
51.3921.222H		399 x 207 x 137	81.63730-6395 * 81.63730-6345 81.63730-6430
15.3921.870H		379 x 176 x 47	81.63733-0082 * 81.63733-6033
51.3922.222H		399 x 222 x 138	81.63730-6399 * 81.63730-6347 81.63730-6432
15.3922.870H		379 x 176 x 47	81.63733-0083 * 81.63733-6034
04.0603.007.000		30 x 6 Ø	
11.3921.110H		399 x 196 x 52	81.63732-0054 * 81.63732-0059 81.63732-0063
11.3921.120H		399 x 210 x 52	81.63732-0055 * 81.63732-0060 81.63732-0064

MAN

392-1	II e1 03★0024		ABS	Ø 28 mm
	II (E1) 02 0925			

MEKRA LANG Group	Beschreibung description descripção descrizione benámenning popis описанье özellik leirás opís	mm	OE
51.3921.224H		399 x 207 x 137	81.63730-6482
51.3923.224H		339 x 222 x 138	81.63730-6487
51.3921.223H		399 x 207 x 137	81.63730-6480
51.3923.223D		399 x 222 x 138	81.63730-6485
15.3920.840H		379 x 176 x 47	81.63733-6049
51.3922.224H		399 x 222 x 138	81.63730-6483
51.3924.224H		399 x 207 x 137	81.63730-6486
51.3922.223H		399 x 222 x 138	81.63730-6481
51.3924.223D		399 x 207 x 137	81.63730-6484
15.3920.840H		379 x 176 x 47	81.63733-6049
11.3921.400		117 x 62 x 9	81.63731-0309 + 81.63731-0366
04.0603.007.000		30 x 6 ø	
11.3921.110H		399 x 196 x 52	81.63732-0054 + 81.63732-0059 81.63732-0063
11.3921.120H		399 x 210 x 52	81.63732-0055 + 81.63732-0060 81.63732-0064

393-1	IV e1 03★0025		ABS	Ø 28 mm
	IV (E1) 02 0924			

MEKRA LANG Group	Beschreibung description descripção descrizione benámenning popis описанье özellik leirás opís	mm	OE
56.3931.343H		188 x 207 x 129	81.63730-6510
56.3931.323H		188 x 207 x 129	81.63730-6512
15.3932.870H		177 x 167 x 38	81.63733-6057
56.3932.343H		188 x 220 x 130	81.63730-6511
56.3932.323H		188 x 220 x 130	81.63730-6513
15.3932.870H		177 x 167 x 38	81.63733-6057
11.3921.400		117 x 62 x 9	81.63731-0309 + 81.63731-0366
04.0603.007.000		30 x 6 ø	
11.3931.110H		187 x 197 x 52	81.63732-0057 + 81.63732-0061 81.63732-0065
11.3931.120H		187 x 209 x 52	81.63732-0056 + 81.63732-0062 81.63732-0066

New Regulation
2003/97/ECE
TGA
TGL
TGM
12/06 →
12/06 - 11/14
12/06 - 11/14



New Regulation
2007/38/ECE
TGA
TGL
TGM
01/07 →
12/06 - 11/14
12/06 - 11/14



TGL Evolution
TGM Evolution
(Euro 6) 12/14
(Euro 6) 12/14

MAN

MAN

392-2	II e1 03★0024 II (E1) 02 0925			Ø 28 mm
--------------	--	--	--	---------

	Beschreibung description descripção descripziune benamining popis omicaawie üzellik leirás opis		
--	--	--	--

51.3920.002.099		24V	399 x 210 x 120	81.63730-6738
51.3920.004.099		24V	399 x 225 x 121	81.63730-6745
51.3920.001.099		24V	399 x 210 x 120	81.63730-6739
51.3920.014.099		24V	399 x 225 x 121	81.63730-6746
51.3920.003.099		24V	399 x 225 x 121	81.63730-6740
51.3920.005.099		24V	399 x 210 x 120	81.63730-6743
51.3920.013.099		24V	399 x 225 x 121	81.63730-6741
51.3920.012.099		24V	399 x 210 x 120	81.63730-6744
19.3920.011.099		24V 1200	379 x 176 x 34	81.63733-6079
12.3920.001.099			399 x 203 x 52	81.63732-0094
12.3920.002.099			399 x 208 x 53	81.63732-0095
11.3921.400		für pour	117 x 62 x 9	81.63731-0309 + 81.63731-0366
04.0603.007.000			30 x 6 ø	



393-2	IV e1 03★0025 IV (E1) 02 0924			Ø 28 mm
--------------	--	--	--	---------

	Beschreibung description descripção descripziune benamining popis omicaawie üzellik leirás opis		
--	--	--	--

56.3930.004.099		24V	187 x 210 x 127	81.63730-6748
56.3930.002.099		24V	187 x 210 x 127	81.63730-6749
56.3930.003.099		24V	188 x 223 x 128	81.63730-6750
56.3930.001.099		24V	188 x 223 x 128	81.63730-6751
19.3930.311.099		24V 300	177 x 167 x 35	81.63733-6080
12.3930.001.099			187 x 197 x 52	81.63732-0096
12.3930.002.099			187 x 209 x 52	81.63732-0097
11.3921.400		für pour	117 x 62 x 9	81.63731-0309 + 81.63731-0366
04.0603.007.000			30 x 6 ø	



579	V e1 03★0109 V (E1) 021179			
------------	---	--	--	--

	Beschreibung description descripção descripziune benamining popis omicaawie üzellik leirás opis		
--	--	--	--

56.5790.002.099		24V	303 x 163 x 88	81.63730-6735 + 81.63730-6578
15.5791.570.099		24V 300	303 x 163 x 55	81.63733-6078

MAN

580	II 03★0097			INTEGR.
	II 020929			
	IV 03★0098			
	IV 020930			

	Beschreibung description descriþão descrizione description benáamning popis öznelik leírás opis		OE

59.5800.101H		943 x 382 x 153	81.63730-6529	TGX
59.5800.102H		943 x 382 x 153	81.63730-6560 + 81.63730-6756	
59.5800.302H		943 x 382 x 153	81.63730-6563 + 81.63730-6767	
59.5800.201H		943 x 382 x 153	81.63730-6531	
59.5800.202H		943 x 382 x 153	81.63730-6561 + 81.63730-6765	
59.5800.203H		943 x 382 x 153	81.63730-6564 + 81.63730-6770	
59.5800.402H		943 x 382 x 153	81.63730-6562 + 81.63730-6758	

58.5800.101H		943 x 281 x 28 ø	81.63731-6638
58.5800.102H		943 x 281 x 28 ø	81.63731-6639

59.5800.121H		943 x 437 x 153	81.63730-6533	TGS
59.5800.122H		943 x 437 x 153	81.63730-6549 + 81.63730-6755	
59.5800.322H		943 x 437 x 153	81.63730-6552 + 81.63730-6764	
59.5800.221H		943 x 437 x 153	81.63730-6534	
59.5800.222H		943 x 437 x 153	81.63730-6550 + 81.63730-6762	
59.5800.223H		943 x 437 x 153	81.63730-6553 + 81.63730-6761	
59.5800.422H		943 x 437 x 153	81.63730-6551 + 81.63730-6757	

58.5800.201H		943 x 334 x 28 ø	81.63731-6640
58.5800.202H		943 x 334 x 28 ø	81.63731-6641

15.5801.840H		381 x 201 x 22	81.63733-6071	a
15.5811.871H		197 x 181 x 42	81.63733-6073	b
15.5811.872H		197 x 181 x 42	81.63733-6072	c

13.5800.100H		634 x 259 x 90	81.63732-0091	
11.5800.100H		631 x 237 x 174	81.63731-0356	
11.5800.200H		paintable	631 x 237 x 174	81.63731-0380

20.5800.410H		289 x 149 x 85	81.63732-0073
20.5800.420H		289 x 149 x 85	81.63732-0074
20.5800.610H		242 x 140 x 94	81.63732-0075
20.5800.620H		242 x 140 x 94	81.63732-0076
20.5800.710H		127 x 116 x 33	81.62410-0107
20.5800.720H		127 x 116 x 33	81.62410-0108
20.5800.750H		13 x 19 ø	81.63732-0090 + 81.62410-0109

579	V 03★0109			
	V 021179			

	Beschreibung description descriþão descrizione description benáamning popis öznelik leírás opis		OE

56.5790.002.099		303 x 163 x 88	81.63730-6735 + 81.63730-6578
15.5791.570.099		303 x 163 x 55	81.63733-6078

TGX / TGS

09/07 - 2021



MAN

TGX / TGS

01/2011



2020
2020
2020

TGX/TGS new
TGL new
TGM new

MAN



MAN

1024	II (E1) 041543 IV (E1) 041542			INTEGR.
-------------	----------------------------------	--	--	---------

	Beschreibung description description description benamning pops omlcauwe bœeilik lefrás opis	mm	
--	---	----	--

L H D	59.1024.001.099		24 V	kurz short		936 x 355 x 206	81.63730-6859		
	59.1024.002.099		24 V	kurz short		936 x 355 x 206	81.63730-6860		
	59.1024.005.099		24 V	lang long		936 x 455 x 288	81.63730-6875		
	59.1024.006.099		24 V	lang long		936 x 455 x 288	81.63730-6874		
	59.1024.009.099		24 V	kurz short		936 x 355 x 206	81.63730-6853		
	59.1024.010.099		24 V	kurz short		936 x 355 x 206	81.63730-6854		
	59.1024.013.099		24 V	lang long		936 x 455 x 288	81.63730-6869		
	59.1024.014.099		24 V	lang long		936 x 455 x 288	81.63730-6868		
	59.1024.017.099		24 V	kurz short		936 x 355 x 206	81.63730-6865		
	59.1024.019.099		24 V	lang long		936 x 455 x 206	81.63730-6878		
	R H D	59.1024.021.099		24 V	kurz short		936 x 355 x 206	81.63730-6863	
		59.1024.022.099		24 V	lang long		936 x 455 x 288	81.63730-6879	
		59.1024.023.099		24 V	kurz short		936 x 355 x 206	81.63730-6861	
		59.1024.024.099		24 V	kurz short		936 x 355 x 206	81.63730-6862	
		59.1024.025.099		24 V	lang long		936 x 455 x 288	81.63730-6877	
		59.1024.026.099		24 V	lang long		936 x 455 x 288	81.63730-6876	
		59.1024.027.099		24 V	kurz short		936 x 355 x 206	81.63730-6855	
59.1024.028.099			24 V	kurz short		936 x 355 x 206	81.63730-6856		
59.1024.029.099			24 V	lang long		936 x 455 x 288	81.63730-6871		
59.1024.030.099			24 V	lang long		936 x 455 x 288	81.63730-6870		
	19.1024.011.099		24 V		379 x 193 x 35	81.63733-6083			
	19.1024.012.099		24 V		379 x 193 x 35	81.63733-6084			
	19.1024.311.099		24 V		204 x 196 x 51	81.63733-6085			
	19.1024.312.099		24 V		204 x 196 x 51	81.63733-6086			
	13.1024.001.099				427 x 244 x 122	81.63732-0111			
	13.1024.002.099				427 x 244 x 122	81.63732-0110			
	13.1024.003.099			paintable	427 x 244 x 122	81.63732-0125			
	13.1024.004.099			paintable	427 x 244 x 122	81.63732-0124			
	12.1024.009.099		für for pour	foot cover top	241 x 137 x 105	81.63732-0115			
	12.1024.010.099		für for pour	foot cover top	241 x 137 x 105	81.63732-0114			
	12.1024.011.099		für for pour	foot cover bottom	215 x 148 x 100	81.63732-0113			
	12.1024.012.099		für for pour	foot cover bottom	215 x 148 x 100	81.63732-0112			

MAN

1020	V (E1) 041389			INTEGR.
-------------	---------------	--	--	----------------

	Beschreibung description description description description description описание omlucavanje özetlik leírás opis		mm	
--	---	--	----	--

56.1020.017.099			LIN-BUS	307 x 279 x 95	81.63730-6845
56.1020.018.099			LIN-BUS	307 x 279 x 95	81.63730-6846
56.1020.020.099				307 x 279 x 95	81.63730-6843
56.1020.015.099				307 x 279 x 95	81.63730-6881
19.1020.213.099				297 x 172 x 62	81.63733-6087
19.1020.613.099				297 x 172 x 62	81.63733-6088
12.1020.003.099				191 x 137 x 41	81.63732-0106

2018

MAN TGX/TGS



MAN

2017

MAN

1013 **NEW** II (E1) 041427   INTEGR.

   OE

TGE

MAN



L H D	1	59.1013.116.199								384 x 330 x 257	7C1857387FP * 7C1857387ES 5, 14, 16, 20, 23, 24, 27 *
		59.1013.117.199								384 x 330 x 257	7C1857387FJ * 7C1857387FC 1, 5, 12, 14, 16, 20, 23, 24, 25, 27 *
		59.1013.216.199								384 x 309 x 314	7C1857388EG * 7C1857388DK 6, 15, 17, 21, 22, 24, 25, 29 *
		59.1013.101.199								384 x 330 x 257	7C1857387FT * 7C1857387ET 4, 5, 14, 16, 18, 23, 27 *
		59.1013.109.199								384 x 330 x 257	7C1857387FK * 7C1857387FD 1, 4, 5, 12, 14, 16, 18, 23, 27 *
		59.1013.201.199								384 x 309 x 314	7C1857388EH * 7C1857388DL 4, 6, 15, 17, 19, 22, 25, 29 *
		59.1013.212.199								384 x 309 x 314	7C1857388EC * 7C1857388DQ 2, 3, 4, 6, 13, 15, 17, 19, 22, 25, 29 *
		59.1013.102.199								384 x 330 x 257	7C1857387FR * 7C1857387FB 4, 5, 14, 16, 18, 23, 26 *
		59.1013.106.199								384 x 330 x 257	7C1857387FM * 7C1857387FF 1, 4, 5, 12, 14, 16, 18, 23, 26 *
		59.1013.202.199								384 x 309 x 314	7C1857388EK * 7C1857388DN 4, 6, 15, 17, 19, 22, 25, 28 *
	R H D		59.1013.316.199							384 x 309 x 314	7C2857387CR * 7C2857387CG 10, 14, 16, 20, 23, 24, 25, 30 *
			59.1013.317.199							384 x 309 x 314	7C2857387CN * 7C2857387CJ 1, 10, 12, 14, 16, 20, 23, 24, 25, 30*
			59.1013.416.199							384 x 330 x 257	7C2857388CB * 7C2857388BL 11, 15, 17, 21, 22, 24, 25, 31 *
			59.1013.301.199							384 x 309 x 314	7C2857387CS * 7C2857387CH 4, 10, 14, 16, 18, 23, 25, 30 *
			59.1013.309.199							384 x 309 x 314	7C2857387CP * 7C2857387CK 1, 4, 10, 12, 14, 16, 18, 23, 25, 30 *
		59.1013.401.199							384 x 330 x 257	7C2857388CC * 7C2857388BM 4, 11, 15, 17, 19, 22, 25, 31 *	
		59.1013.412.199							384 x 330 x 257	7C2857388BT * 7C2857388BP 2, 3, 4, 11, 13, 15, 17, 19, 22, 25, 31 *	
L H D	2	59.1013.501.199							384 x 434 x 191	7CB857387BE v 7CB857387BA 4, 5, 14, 16, 18, 23, 25, 32 *	
		59.1013.509.199							384 x 434 x 191	7CB857387BC v 7CB857387AT 4, 5, 7, 12, 14, 16, 18, 23, 25, 32 *	
		59.1013.601.199							384 x 434 x 238	7CB857388AL v 7CB857388AJ 4, 6, 15, 17, 19, 22, 25, 33 *	
		59.1013.612.199							384 x 434 x 238	7CB857388AN v 7CB857388AG 4, 6, 8, 9, 13, 15, 17, 19, 22, 25, 33 *	

* Der Komplettspiegel besteht aus den aufgelisteten Positionen.
Die Zuordnung zu den entsprechenden Artikelnummern befindet sich auf der rechten Seite.
The complete mirror consists of the items listed.
The allocation to the corresponding article number is on the right-hand side.

MAN

1013	NEW	II (E1) 041427			INTEGR.	
		Beschreibung description descripción descrizione beschreibung oписание opís opis			 mm	OE
19.1013.011.099				a	211 x 169 x 19	MAN 65.63733-0002 MAN 65.63733-0015
19.1013.012.099				b	211 x 169 x 19	MAN 65.63733-0006 MAN 65.63733-0014

2017

TGE



Pos.	MEKRA	MAN	FM	LTE	GNSS	Navigation	1200	12V	U	Rumpfspiegel - carcase
1	08.1013.007.000	65.28205-6000								
2	08.1013.008.000	65.28205-6001								
3	08.1013.009.000	65.28205-6002								
4	08.1013.010.000	65.63734-0002								
5	08.1013.012.100	65.25320-6001								
6	08.1013.013.100	65.25320-6002								
7	08.1013.107.000	65.28205-0005								
8	08.1013.108.000	65.28205-0006								
9	08.1013.109.000	65.28205-0007								
10	08.1013.712.100	65.25320-6003								
11	08.1013.713.100	65.25320-6004								
12	11.1013.015.000	65.28240-0000								
13	11.1013.016.000	65.28240-0001								
14	13.1013.001.000	65.63732-0002								
15	13.1013.002.000	65.63732-0003								
16	13.1013.003.000	65.63732-0000								
17	13.1013.004.000	65.63732-0001								
18	19.1013.011.004	65.63733-0015								
19	19.1013.012.004	65.63733-0014								
20	19.1013.411.004	65.63733-0013								
21	19.1013.412.004	65.63733-0012								
22	61.1013.002.004	65.63732-6001								
23	61.1013.003.004	65.63732-6000								
24	61.1013.001.004	65.63734-0000								
25	61.1013.005.004	65.63731-6008								
26	61.1013.103.004	65.63731-6031								
27	61.1013.116.004	65.63731-6033								
28	61.1013.203.004	65.63731-6032								
29	61.1013.216.004	65.63731-6034								
30	61.1013.316.004	65.63731-6037								
31	61.1013.416.004	65.63731-6038								
32	61.1013.501.004	65.63731-6025								
33	61.1013.601.004	65.63731-6026								

MAN

MAN

276

II 02★0524 II 02★ 0423
 II 010524 II 010423
 II 03★0022 II 03★0088
 II 020905 II 020923



Beschreibung
 description
 descripción
 descrizione
 descripción
 benämning
 popis
 omicaame
 ბეჩიკი
 leiras
 opis



1	59.2762.101		592 x 205 x 120	
	51.3732.326		384 x 205 x 116	81.63730-6374 ♦ 81.63730-6390
	15.3731.470H		369 x 190 x 42	81.63733-6029 ♦ 81.63733-0075
	11.3730.210H		367 x 187 x 60	81.63732-0058
2	59.2762.322		592 x 205 x 120	
	51.3732.326		384 x 205 x 116	81.63730-6374 ♦ 81.63730-6390
	15.3731.470H		369 x 190 x 42	81.63733-6029 ♦ 81.63733-0075
	11.3730.210H		367 x 187 x 60	81.63732-0058
	59.2762.422		592 x 205 x 120	
	51.3731.326		384 x 205 x 116	81.63730-6375
	15.3731.470H		369 x 190 x 42	81.63733-6029 ♦ 81.63733-0075
	11.3730.210H		367 x 187 x 60	81.63732-0058
	20.2710.620		124 x 59 x 21 [500]	36.63731-6000

271

II 02★0524
 II 010524



Beschreibung
 description
 descripción
 descrizione
 descripción
 benämning
 popis
 omicaame
 ბეჩიკი
 leiras
 opis



1	59.2712.111		783 x 703 x 212	83.63700-6502 ♦ 81.63700-6091
	51.3731.326		384 x 205 x 116	81.63730-6375
	15.3731.470H		369 x 190 x 42	81.63733-6029 ♦ 81.63733-0075
	15.2711.114		165 x 93 x 25	81.63733-6027
	11.3730.210H		367 x 187 x 60	81.63732-0058
	20.2700.200H		126 x 25ø	
	20.2710.200H		183 x 181 x 84	81.63731-0289
	20.2480.216H		108 x 50 x 15 [2000]	83.63731-6507
2	59.2712.114		641 x 701 x 200	83.63700-6501 ♦ 81.63700-6092
	51.3732.326		384 x 205 x 116	81.63730-6374 ♦ 81.63730-6390
	15.3731.470H		369 x 190 x 42	81.63733-6029 ♦ 81.63733-0075
	15.2711.114		165 x 93 x 25	81.63733-6027
	15.2712.114		152 x 128 x 23	81.63733-6028
	11.3730.210H		367 x 187 x 60	81.63732-0058
	20.2700.200H		126 x 25ø	
	20.2710.200H		183 x 181 x 84	81.63731-0289
		20.2480.217H		108 x 50 x 15 [5000]

2002
 2002
 09/2012

Euroliner
 Trendliner
 PLAXTON: Elite



09/99
 09/01
 2002
 2003

Intercity Mega S 2000
 R07/08, A 20
 Euroliner
 Trendliner
 Tourliner
 Lions Coach Fortuna



MAN

278		II 03★0128 II 020951 IV 03★0129 IV 020952		I+IV Truck		ABS			
MEKRA LANG Group		Beschreibung description descripção descripzione benamning pöpsis onycauwe brevlik leirrás opis		mm		OE			
59.2780.120.099		684 x 247 x 174	88.63700-6059	1					
59.2781.120		684 x 247 x 174							
59.2780.200.001		684 x 247 x 174							
59.2780.140.001		684 x 247 x 174	83.63700-6510	2					
59.2780.150.001		684 x 247 x 174	83.63700-6511						
59.2780.180.001		684 x 247 x 174							
59.2780.170.001		684 x 247 x 174							
20.2710.620		124 x 59 x 21 [500]							
20.2710.650		124 x 59 x 21 [3500]							
08.3200.233H		42 x 42 x 54	81.25525-0232						
15.2780.840		307 x 177 x 22	81.63733-0113						
15.2780.841F		307 x 177 x 22							
15.2780.870		177 x 177 x 34	81.63733-0112						
15.2780.871F		177 x 177 x 34							
11.2780.910		681 x 229 x 104	81.63732-0088						
11.2780.920		681 x 229 x 104	36.63732-0006						
08.5752.012		130 x 120 x 53							
08.5752.024.099		130 x 120 x 53							

MAN Lion's City
 MAN Lion's Regio
 MAN Lion's Star
 Inter Deck, IRISBUS (Citellis),
 KRAVTEX, LAZ, SOLARIS (Urbino),
 VDL (Citea), VOLVO 7900H,
 Heuliez, Caetano, Plaxton, Scania
 2007



1



2

MAN

MAN

277		II E1 03★0084 II E1 020915	Truck II	ABS	INTEGR.
MEKRA LANG Group		Beschreibung description descripção descripzione benamning pops omrcauwe brielik otpis		mm	OE
59.2770.210.099			1001 x 720 x 254	88.63700-6062	
59.2770.211.099			1001 x 720 x 254	88.63700-6066	
59.2771.210.099			1001 x 720 x 254	88.63700-6060	
59.2770.310.099			1001 x 720 x 254	2227 4292 (Volvo) 272 3896 (Scania)	
09.2770.210		(→ 59.2770.210.099)	6050 x 6 ø	88.25426-6837	
09.2770.211 + 09.2770.210		(→ 59.2770.211.099)	6050 x 6 ø	33.25404-6190 + 88.25426-6837	
09.2770.001.000		(→ 59.2771.210.099)	6050 x 6 ø		
08.2910.001.002	LED			33.25203-6001	
09.2910.003.099		(for LED)	6050 x 6 ø		
08.3200.233H			42 x 42 x 54	81.25525-0232	
08.2770.001.000			45 x 40 x 44	81.25505-6247	
08.3950.001.099	Control Unit (→ 59.2771.210.099)		40 x 30 x 30		
15.2771.840			307 x 183 x 23	81.63733-0110	
15.2771.870			206 x 166 x 37	81.63733-0111	
61.2770.210			670 x 280 x 253	81.63730-0083	
61.2772.211.099			670 x 280 x 253		
61.2770.211		(→ 59.2770.210.099 + 59.2770.211.099)	817 x 192 x 130	81.63731-0373	
11.2770.920			669 x 254 x 237	81.63732-0087	
11.2770.102		1	707 x 123 x 185	36.63732-0000	
11.2770.202		2	399 x 149 x 129	36.63732-0002	
11.2770.302		3	268 x 151 x 118	36.63732-0001	
11.2770.402		4	399 x 153 x 128	36.63732-0003	
61.2772.100			399 x 172 x 129	81.63732-0089	
08.5752.024.099			130 x 120 x 53	81.63734-6001	
61.2770.900.099	KIT 1			36.63732-6000	
61.2770.901.099	KIT 2				

MAN Lion's City
MAN Lion's Regio
MAN Lion's Star
IRISBUS (Citelis), KRAVTEX, LAZ,
VDL (Citea), VOLVO 7900H,
Heuliez, Caetano, Plaxton, Scania
2007



KIT 1



Schamierdeckel
Hinge cover



Scharnierklemme
Hinge clamp



Schenkeifeder
Spring screw

KIT 2



Spann Schlüssel
Wrench



Spannhebel
Bolt lever



Druckfeder
Compression spring

MAN

1041		II (E1) 041480				INTEGR.
		Beschreibung description descripção descripção description benamining popis onivcaune bœellik veikrás opis				OE
59.1041.001.099		636 x 907 x 250	36.63700-6018			
59.1041.002.099		636 x 907 x 250	33.63700-6004			
59.1041.003.099		636 x 907 x 250	83.63700-6530			
59.1041.004.001		636 x 907 x 250		5		
15.2780.840		178 x 307 x 22	36.63733-0011	a		
19.2910.002.099		172 x 184 x 39	36.63733-0012	b		
12.1041.001.099		274 x 643 x 165	36.63732-0037			
12.1041.002.099		114 x 313 x 63	36.63732-0035	1	back	
12.1041.003.099		112 x 194 x 91	36.63732-0034	2	front	
12.1041.004.099		113 x 349 x 75	36.63732-0033	3	front	
12.1041.005.099		90 x 470 x 118	36.63732-0036	4	back	
08.1024.124.099		120 x 130 x 45 mm	81.63734-6006 31.39595 (Scania)	a		
09.1041.002.099		2400	36.25404-6033	a		
09.1041.004.099		2400	33.28104-6355	b		

2019 →
Stadtbusse MAN
(Lion's City)



5 Unter 2 m verbaubar und abklappbar
Can be installed and folded away below 2 meters



2019 →

Stadtbusse MAN
(Lion's City)

1042		II (E1) 041481 IV (E1) 041482				INTEGR.
		Beschreibung description descripção descripção description benamining popis onivcaune bœellik veikrás opis				OE
59.1042.001.099		685 x 176 x 237	36.63700-6017			1
59.1042.005.099		685 x 176 x 237	33.63700-6003			
59.1042.003.099		685 x 176 x 237	36.63700-6019			2
15.2780.840		178 x 307 x 22	36.63733-0011	a		
19.2910.001.099		154 x 183 x 31	36.63733-0010	b		
12.1042.001.099		232 x 528 x 87	36.63732-0040			
12.1042.002.099		232 x 528 x 87	36.63732-0041			
61.1042.005.099		127 x 172 x 111			for door	
61.1042.006.099		167 x 160 x 163			for A-Pillar	
08.1024.124.099		120 x 130 x 45 mm	81.63734-6006 31.39595 (Scania)	a		
20.1042.002.099		2100	36.63731-6012			
20.1042.003.099		2500	36.63731-6013			
09.1041.004.099		2400	33.28104-6355	b		



MERCEDES

1013 - 2644
EvoBus D 303, 404, 405, 407
08/73 - 12/86



253		II e1 02★14067 II (E1) 0114067		Truck II	ABS	Ø 18 mm
MEKRA LANG Group		Beschreibung description descripção descrizione benamning popis omircaune üzeylik leirás opis		mm		OE
51.2530.120H		370 x 182 x 64	381 810 25 16* 000 810 27 16 281 810 71 16* 000 810 62 16 000 811 12 33* 314 810 26 16 381 810 71 16* 663 810 08 16 673 810 08 16* 673 810 40 16 000 811 33 33* 001 811 87 33 000 811 20 33* 000 811 64 33 000 811 21 33			
40.2530.222H		356 x 170 x 3	000 811 33 33* 001 811 87 33 000 811 21 33			
61.2530.110H		55 x 43 x 36	000 811 02 39			
51.2530.140H		370 x 182 x 64	381 810 73 16* 381 810 26 16 000 810 23 16* 301 810 21 16 314 810 26 16* 673 810 42 16			
40.2530.422H		356 x 170 x 3				
09.2070.101H		2070 x 9ø	000 150 55 33			
61.2530.110H		55 x 43 x 36	000 811 02 39			











11/77
12/98

LK08 - 1113
LN2 (LK)



254		II e1 01★14068		Truck II	ABS	Ø 18 mm
MEKRA LANG Group		Beschreibung description descripção descrizione benamning popis omircaune üzeylik leirás opis		mm		OE
51.2540.120H		305 x 183 x 60	314 810 13 16* 000 810 04 16 000 810 48 16* 673 810 39 16 000 811 35 33* 001 811 90 33 000 811 19 33			
40.2540.222H		291 x 170 x 3	000 811 35 33* 001 811 90 33 000 811 19 33			
61.2530.110H		55 x 43 x 36	000 811 02 39			
51.2540.130H		305 x 183 x 60	314 810 19 16* 000 810 06 16 000 810 20 16			
40.2540.222H		291 x 170 x 3	000 811 35 33* 001 811 90 33 000 811 19 33			
09.2070.101H		2070 x 9ø	000 150 55 33			
61.2530.110H		55 x 43 x 36	000 811 02 39			
51.2540.140H		305 x 183 x 60	314 810 20 16* 673 810 41 16			
40.2540.422H		291 x 170 x 3	001 811 90 33 + 000 821 08 29			
09.2070.101H		2070 x 9ø	000 150 55 33			
61.2530.110H		55 x 43 x 36	000 811 02 39			













MERCEDES

375	II [e1] 03★0123 II [E] 020941 II [e1] 02★0505 II [E] 010505	 	Ø 28 mm
			
Beschreibung description descripción descrizione benámining þopps önniçauwe leirrás optis			OE
61.3752.147H		380 x 170 x 68	000 810 02 79
15.3752.470H		380 x 170 x 15	001 811 34 33+ 001 811 73 33
61.3780.100H		74 x 65 x 14	000 811 13 07
61.3752.167H		380 x 170 x 68	000 810 03 79
15.3752.470H		380 x 170 x 15	001 811 34 33+ 001 811 73 33
61.3780.100H		74 x 65 x 14	000 811 13 07

Atego (LKN)
Axor
Unimog U 20
01/98 - 09/04
09/01 - 09/04









MERCEDES

377 377-1	IV [e1] 02★0462 IV [E] 010462 IV [e1] 03★0019	 	Ø 28 mm
			
Beschreibung description descripción descrizione benámining þopps önniçauwe leirrás optis			OE
61.3770.147H		200 x 200 x 155	 000 810 96 16 + 001 811 21 33 + 000 811 13 07
15.3774.410H		200 x 200 x 15	001 811 21 33
61.3772.147H		200 x 200 x 118	000 810 96 16
61.3780.100H		74 x 65 x 14	000 811 13 07
61.3773.147H		200 x 200 x 155	 001 810 92 16 + 000 811 13 07
15.3771.174H		200 x 200 x 15	001 811 60 33
61.3780.100H		74 x 65 x 14	000 811 13 07



Atego (LKN)
Axor
01/98 - 09/04
09/01 - 09/04

375 A			Ø 28 mm
			
Beschreibung description descripción descrizione benámining þopps önniçauwe leirrás optis			OE
58.3752.100		639 x 325 x 28 ø	973 810 03 14
58.3752.200		639 x 325 x 28 ø	973 810 04 14
20.3750.710.099		136 x 82 x 73	000 811 03 61
20.3750.720.099		136 x 82 x 73	000 811 04 61

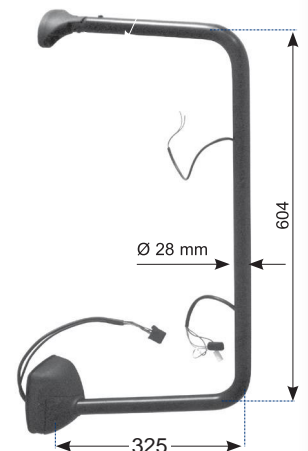

MERCEDES

Atego II (LKN)
Axor II

10/04
10/04



575	II (E1) 021144		ABS	Ø 28 mm
MEKRA LANG Group		mm		OE
Beschreibung description descripção descripziune descripziune benamning popis opričkanje úzelik leirás opís				
51.5750.003.099		24 V	439 x 219 x 124	000 810 17 79 + 000 810 22 79
51.5750.004.099		24 V	439 x 219 x 124	000 810 14 79 + 000 810 23 79
09.5750.220.099		06/10	250	000 820 28 13
51.5750.001.099		24 V	439 x 219 x 124	000 810 18 79 + 000 810 20 79
51.5750.002.099		24 V	439 x 219 x 124	000 810 15 79 + 000 810 21 79
09.5750.001.099		06/10	335	000 820 27 13
19.5750.011.099		24 V 1200	435 x 196 x 39	002 811 46 33
15.5750.840H		24 V 1200	431 x 186 x 15	001 811 99 33
61.5750.100H			86 x 79 x 77	000 811 20 07





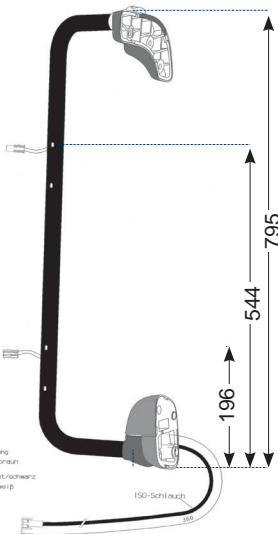









577	IV (E1) 021145		ABS	Ø 28 mm
MEKRA LANG Group		mm		OE
Beschreibung description descripção descripziune descripziune benamning popis opričkanje úzelik leirás opís				
51.5770.001.099		24 V	214 x 199 x 116	000 810 16 79 + 000 810 24 79
19.5770.311.099		24 V 300	203 x 200 x 43	002 811 47 33
15.5770.870H		24 V 300	192 x 186 x 15	002 811 00 33
09.5750.220.099		06/10	250	000 820 28 13
61.5750.100H			86 x 79 x 77	000 811 20 07



575 A			Ø 28 mm	
MEKRA LANG Group		mm		OE
Beschreibung description descripção descripziune descripziune benamning popis opričkanje úzelik leirás opís				
58.5752.100H		03/13	795 x 321 x 28 Ø	001 810 97 14
58.5752.200H		03/13	795 x 376 x 28 Ø	001 810 98 14
58.5752.300H		03/13	795 x 376 x 28 Ø	001 810 99 14
58.5752.400E		03/13	795 x 321 x 28 Ø	002 810 00 14
58.5750.012.199		04/13	795 x 322 x 28 Ø	002 810 85 14
58.5750.005.199		04/13	795 x 322 x 28 Ø	002 810 94 14
20.5750.710.099			134 x 80 x 74	000 811 18 07
20.5750.720.099			134 x 80 x 74	000 811 19 07

MERCEDES

579	V  03★0109 V  021179	 	
	Beschreibung description descripção descripziune benamning popis описаније özellik leirás opis		OE
56.5790.004.099	   	303 x 163 x 88	002 810 08 16
15.5791.470H	 	303 x 163 x 55	002 811 22 33

*Atego (LKN)
Axor
Atego II (LKN)
Axor II*











*01/98 - 05/08
09/01 - 09/04
10/04 →
10/04 →*





























New Regulation ECE R46/04



MERCEDES

1004	V  04 1341	 	
	Beschreibung description descripção descripziune benamning popis описаније özellik leirás opis		OE
56.1004.001.099	   	338 x 275 x 105	002 810 60 16

396	VI  03★0017	 	INTEGR.
	Beschreibung description descripção descripziune benamning popis описаније özellik leirás opis		OE
59.3962.210H	      1	1261 x 303	973 810 73 16
59.3964.210H	      2	1145 x 265	940 810 55 16
56.3960.148H	 	130 x 250 ø	 000 810 08 79 +  001 811 69 33 +  000 811 13 07
15.3961.174H	  	45 x 250 ø	001 811 69 33
61.3780.100H	 	74 x 65 x 14	000 811 13 07

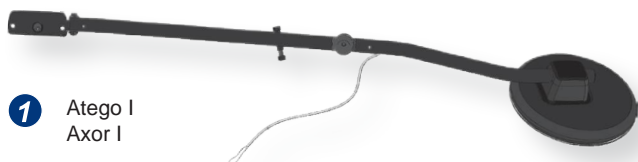

MERCEDES

579	V e1 03★0109			
	V (E1) 021179			
	Beschreibung description descripção descripziune benamining popis opis opis			OE
56.5790.004.099		303 x 163 x 88	002 810 08 16	
15.5791.470H		303 x 163 x 55	002 811 22 33	

Actros (SKL) I+II
Econic
09/96 - 05/08
03/98 →



1004	V (E1) 04 1341			
	Beschreibung description descripção descripziune benamining popis opis opis			OE
56.1004.001.099		338 x 275 x 105	002 810 60 16	

New Regulation ECE R46/04



MERCEDES

396	VI e1 03★0017			INTEGR.
	Beschreibung description descripção descripziune benamining popis opis opis			OE
59.3965.210H		1219 x 303	943 810 47 16	
56.3960.148H		130 x 250 ø	000 810 08 79 + 001 811 69 33 + 000 811 13 07	
15.3961.174H		45 x 250 ø	001 811 69 33	
61.3780.100H		74 x 65 x 14	000 811 13 07	

Actros I + II



MERCEDES

ACTROS MP3



1012	ECE		II + IV Truck		
MEKRA LANG Group		Beschreibung description descripção descripzione benämning popis opisacivne özelliik leirás opis	mm	OE	
19.1012.002.099		1200 24V	a	401 x 200 x 55	002 811 33 33
19.1012.003.099		1200 24V	a	401 x 200 x 55	002 811 34 33
19.1012.000.099		300 24V	b	196 x 193 x 44	002 811 37 33
19.1012.001.099		300 24V	b	196 x 193 x 44	002 811 38 33

MERCEDES

ACTROS MP4
ANTOS
AROCS
(SFTP)



10/2011
07/2012
05/2013

600	II (E1) 02★1112 IV (E1) 02★1113		II + IV Truck	ABS	INTEGR.
MEKRA LANG Group		Beschreibung description descripção descripzione benämning popis opisacivne özelliik leirás opis	mm	OE	
15.6000.001.099		1200 24V	a	430 x 193 x 34	002 811 63 33
15.6000.002.099		1200 24V	a	430 x 193 x 34	002 811 64 33
15.6000.003.099		300 24V	b	204 x 236 x 51	002 811 65 33
15.6000.004.099		300 24V	b	204 x 236 x 51	002 811 66 33

Komplettsystem (MP3 + MP4) bei Mercedes erhältlich
complete system (MP3 + MP4) available at Mercedes

ACTROS MP3
ACTROS MP4
ANTOS
AROCS
(SFTP)



10/2011
07/2012
05/2013

1004	V (E1) 04 1341		V Truck	ABS	
MEKRA LANG Group		Beschreibung description descripção descripzione benämning popis opisacivne özelliik leirás opis	mm	OE	
56.1004.001.099				338 x 275 x 105	002 810 60 16

New Regulation ECE R46/04



Electronics and Accessories

Product Catalog for Camera Monitor Systems and Active Alarm Systems

Download



MERCEDES

1994 →
EvoBus Kombibus
Ares (Renault, Karosa, Iveco)



281	II [E1] 02★0447	Truck II	ABS	INTEGR.
	II [E1] 010447			
	II [E1] 02★0448			
MEKRA LANG Group		mm		OE
59.2810.111H	[Icons]	24V	470 x 230 x 85	
59.2810.113H	[Icons]	24V	470 x 230 x 85	
15.2810.480H	[Icons]	1800 24V	409 x 168 x 6	
11.2810.200H	[Icons]		460 x 180 x 50	

1999 →

Conecto CÜ
Intouro



398	II [E1] 03★0123	Truck II	ABS	[Icon]
	II [E1] 020941			
	II [E1] 02★0505			
	II [E1] 010505			
MEKRA LANG Group		mm		OE
1	59.3980.021H	[Icons]	24V 90°	551 x 278 x 147 671 810 09 16
	59.3980.022H	[Icons]	24V 90°	551 x 1278 x 47 671 810 13 16
2	59.3980.122	[Icons]	24V 21°	435 x 246 x 143 628 810 31 16
3	59.3980.011H	[Icons]	24V 110°	474 x 733 x 166 671 810 07 16
	59.3980.012	[Icons]	24V 110°	474 x 733 x 166 671 810 12 16
	59.3980.111	[Icons]	24V 132°	474 x 733 x 166 628 810 33 16
4	59.3980.132	[Icons]	24V 132°	622 x 758 x 224 628 810 37 16
	59.3980.141	[Icons]	24V 110°	622 x 758 x 224 633 810 01 16
	59.3980.142	[Icons]	24V 110°	622 x 758 x 224 633 810 02 16
	61.3752.147H	[Icons]	24V	380 x 170 x 68 000 810 02 79
	61.3752.167H	[Icons]		380 x 170 x 68 000 810 03 79
	15.3752.470H	[Icons]	1800 24V	380 x 170 x 15 001 811 34 33 + 001 811 73 33
	61.3773.147H	[Icons]		200 x 200 x 155 001 810 92 16
	15.3771.174H	[Icons]	300 24V	200 x 200 x 15 001 811 60 33
	61.3780.100H	[Icons]		74 x 65 x 14 000 811 13 07
	20.2480.216H	[Icons]		108 x 50 x 15 [2000]
	20.2480.217H	[Icons]		108 x 50 x 15 [5000]



09/97 →
10/03 →
09/99 →
09/97 →
Travego
Tourino
Setra TC 400
Multego
Tourismo



395	II [E1] 02★0620	II [E1] 020926	II + V	
	II [E1] 010620	V [E1] 03★0174		
	II [E1] 03★0047	V [E1] 020998		
MEKRA LANG Group		mm		OE
	15.3951.174	[Icons]	1800 24V	a 368 x 174 x 15 629 811 00 33
	15.3951.114	[Icons]	240 24V	b 202 x 153 x 15 629 811 01 33

MERCEDES

249 K	III e1 01★17023		PP	① Ø 10 mm ② Ø 12 mm
Beschreibung description description descripção descripziune benamning popis opniscawe bœllik leirás opis				OE
51.2491.121H		①	210 x 140 x 21	460 810 01 16 + 601 810 02 16 460 810 03 16
51.2491.122H		②	210 x 140 x 21	601 810 01 16

249 L	II e1 02★14035 II (E1) 0114035		PP	① Ø 10 mm ② Ø 14 - 20 mm
Beschreibung description description descripção descripziune benamning popis opniscawe bœllik leirás opis				OE
51.2493.121H		①	247 x 157 x 61	612 810 01 66 + 611 810 01 16
51.2493.127H		②	247 x 157 x 61	

349 349 TW	II e1 02★0384 II (E1) 010384 II e1 02★0418 II (E1) 010418		ABS	① INTEGR. ③ Ø 18 mm
Beschreibung description description descripção descripziune benamning popis opniscawe bœllik leirás opis				OE
51.3490.110H		①	283 x 295 x 80	901 810 01 16 + 901 810 55 16
15.3491.071H			238 x 142 x 6	001 811 06 33
51.3490.120H		①	283 x 340 x 80	901 810 02 16 + 901 810 64 16
15.3491.072H			238 x 142 x 6	001 811 07 33
51.3490.112H		①	283 x 295 x 80	901 810 09 16 + 901 810 57 16
15.3491.371H			238 x 142 x 6	001 811 05 33
51.3490.122H		①	283 x 340 x 80	901 810 10 16 + 901 810 66 16
15.3491.372H			238 x 142 x 6	001 811 04 33
56.3491.110H		②	175 x 116 x 70	901 810 10 93 + B 66 5603 97
15.2711.214H			165 x 93 x 15	
56.3492.110H		②	175 x 116 x 70	901 810 11 93 + B 66 5603 98
15.2711.214H			165 x 93 x 15	
59.3491.110H		③	283 x 495 x 80	901 810 25 16 + 901 810 58 16
59.3492.110H			283 x 465 x 80	901 810 37 16 + 901 810 61 16
15.3491.071H			238 x 142 x 6	001 811 06 33
59.3491.120H		③	283 x 535 x 80	901 810 26 16 + 901 810 67 16
59.3492.120H			283 x 535 x 80	901 810 38 16 + 901 810 70 16
15.3491.072H			238 x 142 x 6	001 811 07 33

05/77 - 07/81
05/79 →
Transporter
207D - 308 (T1, TN)
Typ 230 GE, 280 GE
Typ 240 GD, 300 GD



08/81 - 02/95
01/95 - 09/95
Transporter
207D - 410 (T1, TN)



①
Sprinter (T1N)

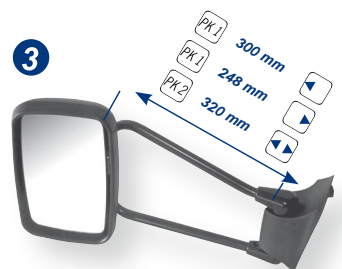

MERCEDES

*Mercedes Sprinter II (NCV3)
10/2005 - 11/2017*

MERCEDES



* mit beheizter Weitwinkel - Glaseinheit, nur verwendbar für Fahrzeuge ab "EURO 5"
with heated wide angle mirror glass unit, suitable from "EURO 5" vehicles only

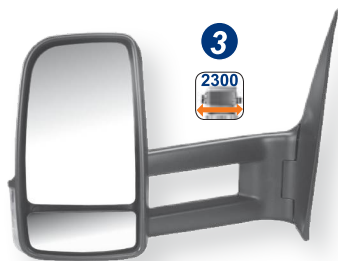

589	II III e1 03★0006 II III E1 020902			INTEGR.
	Beschreibung description descripción descripción benámening p.p.p.p.s omírcauwe búeillik íritras opis		OE	

	L H D	1	51.5891.111.199					344 x 315 x 182	906 810 48 16 + 906 810 18 93	
				12 V					906 810 30 93	
			51.5891.112.199 *					344 x 315 x 182	906 810 30 93	
			51.5891.113.199					344 x 315 x 182	906 810 60 16	
			51.5891.114.199 *					344 x 315 x 182	906 810 42 93	
			51.5894.112.199 *					344 x 315 x 182	906 810 65 93	
	R H D		51.5891.311.199					344 x 345 x 182	906 810 51 16 + 906 810 21 93	
			51.5894.310.199					344 x 345 x 182	906 810 64 93	
			51.5891.312.199 *					344 x 345 x 182	906 810 33 93	
			51.5891.313.199					344 x 345 x 182	906 810 63 16	
			51.5891.314.199 *					344 x 345 x 182	906 810 45 93	
	L H D		51.5891.211.199					344 x 345 x 182	906 810 49 16 + 906 810 19 93	
			51.5891.212.199 *					344 x 345 x 182	906 810 31 93	
			51.5891.213.199					344 x 345 x 182	906 810 61 16	
			51.5891.214.199 *					344 x 345 x 182	906 810 43 93	
	R H D		51.5894.212.199 *					344 x 345 x 182	906 810 66 93	
			51.5894.410.199					344 x 315 x 182	906 810 63 93	
			51.5891.412.199 *					344 x 315 x 182	906 810 32 93	
			51.5891.413.199					344 x 315 x 182	906 810 62 16	
			51.5891.414.199 *					344 x 315 x 182	906 810 44 93	
	L H D	2	51.5892.111.199					344 x 509 x 182	906 810 52 16 + 906 810 22 93	
			51.5892.112.199 *					344 x 509 x 182	906 810 34 93	
			51.5892.113.199					344 x 509 x 182	906 810 64 16	
	R H D		51.5892.311.199					344 x 460 x 182	906 810 55 16 + 906 810 25 93	
			51.5892.312.199 *					344 x 460 x 182	906 810 37 93	
			51.5892.313.199					344 x 460 x 182	906 810 67 16	
			51.5895.312.199 *					344 x 460 x 182	906 810 80 93	
	L H D		51.5892.211.199					344 x 460 x 182	906 810 53 16 + 906 810 23 93	
			51.5892.212.199 *					344 x 460 x 182	906 810 35 93	
			51.5892.213.199					344 x 460 x 182	906 810 65 16	
	R H D		51.5892.411.199					344 x 509 x 182	906 810 54 16 + 906 810 24 93	
			51.5892.413.199					344 x 509 x 182	906 810 66 16	
			51.5895.412.199 *					344 x 509 x 182	906 810 79 93	
	L H D	3	51.5893.111.199					344 x 543 x 182	906 810 56 16 + 906 810 26 93	
			51.5893.112.199 *					344 x 543 x 182	906 810 38 93	
			51.5893.113.199					344 x 543 x 182	906 810 68 16	
			51.5893.211.199					344 x 511 x 182	906 810 57 16 + 906 810 27 93	
			51.5893.212.199 *					344 x 511 x 182	906 810 39 93	
			51.5893.213.199					344 x 511 x 182	906 810 69 16	

MERCEDES

589

II III e1 03★0006

II III E1 020902



Beschreibung
description
description
description
description
benamning
Popis
omircauwe
brevlik
letrals
opis



OE

15.5891.741H		236 x 155 x 16	002 811 15 33	a
15.5891.742H		236 x 155 x 16	002 811 16 33	
15.5891.611H		154 x 59 x 19	002 811 19 33	b
15.5891.612H		154 x 59 x 19	002 811 20 33	
19.5890.011.099		240 x 158 x 21	002 811 52 33	c
19.5890.012.099		240 x 158 x 21	002 811 53 33	
19.5891.011.099		240 x 158 x 21	002 811 56 33	
19.5891.012.099		240 x 158 x 21	002 811 57 33	
08.5890.300.099		113 x 32 x 15	000 440 00 15	
08.5890.301.099		113 x 32 x 15	000 440 01 15	
15.5891.721.099		157 x 65 x 20	002 811 39 33	d
15.5891.722.099		157 x 65 x 20	002 811 40 33	
13.5890.110.199		344 x 218 x 82	000 811 10 22	
13.5890.210.199		344 x 218 x 82	000 811 11 22	
13.5890.120.099		344 x 201 x 82	001 811 00 22	
13.5890.220.099		344 x 201 x 82	001 811 01 22	
14.5890.100.099		337 x 192 x 56	000 813 04 36	
14.5890.200.099		337 x 192 x 56	000 813 05 36	
08.5892.001.099		13 133 x 118 x 88	001 822 89 20 + 000 820 12 77	
08.5892.002.099		13 133 x 118 x 88	001 822 93 20 + 000 820 12 77	
08.5892.003.099		13 133 x 118 x 88	001 822 90 20 + 000 820 12 77	
08.5892.004.099		13 133 x 118 x 88	001 822 92 20 + 000 820 12 77	
08.5892.105.099		12 51 x 27 ø	000 820 12 77	

Mercedes Sprinter II
(NCV3) 10/05 - 09/10



MERCEDES

Sprinter II
Euro 5 + 6 10/2010 - 11/2017

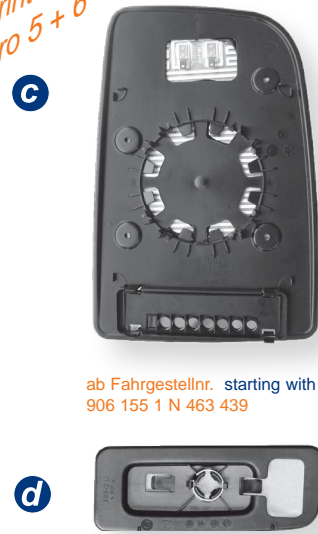

ab Fahrgestellnr. starting with chassis no.
906 155 1 N 463 439



ab Fahrgestellnr. starting with chassis no.
906 155 1 N 416 545



2018

MERCEDES

1039

II (E1) 041469



INTEGR.



Beschreibung
description
description
descripção
description
benamning
pops
omrcauwe
bueilikk
reirras
opis



Sprinter III
W907 und W910



LHD

RHD

59.1039.125.099		423 x 280 x 160	9108100300
59.1039.225.099		423 x 280 x 160	9108100400
59.1039.101.099		423 x 280 x 160	9108108901
59.1039.201.099		423 x 280 x 160	9108109001
59.1039.105.099		423 x 280 x 160	9108101900
59.1039.205.099		423 x 280 x 160	9108102000
59.1039.175.099		423 x 280 x 160	9108100500
59.1039.275.099		423 x 280 x 160	9108100600
59.1039.151.099		423 x 280 x 160	9108109101
59.1039.251.099		423 x 280 x 160	9108109201
59.1039.158.099		423 x 280 x 160	9108109501
59.1039.258.099		423 x 280 x 160	9108109601
59.1039.155.099		423 x 280 x 160	9108102100
59.1039.255.099		423 x 280 x 160	9108102200
19.1039.411.099		207 x 139 x 20	9108112500
19.1039.412.099		207 x 139 x 20	9108112400
19.1039.011.099		207 x 139 x 20	9108112700
19.1039.012.099		207 x 139 x 20	9108112600
19.1039.811.099		207 x 139 x 20	9108112900
19.1039.812.099		207 x 139 x 20	9108112800
19.1039.311.099		137 x 70 x 20	9108113700
19.1039.312.099		137 x 70 x 20	9108113600
13.1039.001.099		308 x 216 x 104	9108114100
13.1039.002.099		308 x 216 x 104	9108114000
11.1039.011.099		308 x 189 x 60	9108113900
11.1039.012.099		308 x 189 x 60	9108113800
08.1039.011.099		Ø 38 x 15	9109065600
61.1039.002.099		Ø 36 x 19	9108250400
08.1039.001.099		87 x 67 x 54	9109064700
08.1039.002.099		87 x 67 x 54	9109064600
11.1039.001.099		62 x 87 x 27	9108114500
11.1039.002.099		62 x 87 x 27	9108114400
08.1039.005.099		35 x 42 x 12	9105420100
08.1039.006.099		35 x 42 x 12	9105420000



MERCEDES

1039

II III (E1) 02★0902



ABS

INTEGR.



Beschreibung
description
descripção
descrizione
description
benamning
popis
omircauwe
özellik
letras
opts



OE

59.1039.501.099		423 x 447 x 270	9108100801	2 L H D R H D
59.1039.601.099		423 x 447 x 270	9108100901	
59.1039.575.099		423 x 447 x 270	9108100601	
59.1039.675.099		423 x 447 x 270	9108100701	
59.1039.551.099		423 x 447 x 270	9108101001	
59.1039.651.099		423 x 447 x 270	9108101101	
59.1039.701.099		423 x 502 x 343	9108101601	3 L H D R H D
59.1039.801.099		423 x 502 x 343	9108101701	
59.1039.751.099		423 x 502 x 343	9108101801	
59.1039.851.099		423 x 502 x 343	9108101901	
19.5890.011.099		8 240 x 158 x 21	0028115233	2 + 3
19.5890.012.099		8 240 x 158 x 21	0028115333	
15.5891.721.099		9 157 x 65 x 20	0028113933	
15.5891.722.099		9 157 x 65 x 20	0028114033	
13.5890.110.199		10 344 x 218 x 82	0008111022	
13.5890.120.099		344 x 218 x 82	0018110022	
13.5890.210.199		10 344 x 218 x 82	0008111122	
13.5890.220.099		344 x 218 x 82	0018110122	
14.5890.100.099		11 337 x 192 x 56	0008130436	
14.5890.200.099		11 337 x 192 x 56	0008130536	
08.5892.105.099		12 Ø 51 x 27	0008201277	
08.5892.002.099		13 133 x 118 x 88	0018229320 + 0008201277	
08.5892.003.099		13 133 x 118 x 88	0018229420 + 0008201277	

Sprinter III
W907 und W910



MERCEDES

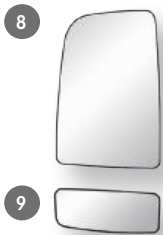

RENAULT

390	II E1 03★0009			Ø 28 mm
	II E1 020914			
	IV E1 03★0010			
	IV E1 020913			

	Beschreibung description descripção descripziune descripção benamning Popis оригинал üzeylik leirás opis		mm	OE

Midlum	Part Number	Icons	Quantity	Dimensions	OE Part Number
	58.3900.143H			800 x 270	7420903722
	58.3900.243H			800 x 270	7420903727
	58.3900.133H			800 x 350	7420903723
	58.3900.233H			800 x 350	7420903732
	58.3900.333H			800 x 350	7420914934
	58.3900.433H			800 x 350	7420914938
	15.3911.871H			200 x 197 x 75	7420862810
	15.3911.872H			200 x 197 x 75	7420862815
	61.3911.110H		1	245 x 236 x 105	7420862809
	61.3911.120H		1	245 x 236 x 105	7420862813
	11.3900.200H			371 x 244 x 80	7420862779
	11.3910.200H			244 x 225 x 75	7420862800
	15.3900.840H			337 x 202 x 25	7420862795
	08.5752.024.099			130 x 120 x 53	7421618499
	61.3900.130H		2	373 x 245 x 101	7485120820
	61.3900.100H		2	373 x 245 x 101	7420862782
	61.3900.110H		2	373 x 245 x 101	7420866665
	61.3900.120H		2	373 x 245 x 101	7420913815
	20.3900.510H			518 x 160 x 98	5010623057
	20.3900.520H			518 x 160 x 98	5010623058

	58 3900 143H			800 x 270	7420903722
	58 3900 243H			800 x 270	7420903727
	61.3910.110H		1	245 x 236 x 105	7420904268
	61.3910.120H		1	245 x 236 x 105	7420904269
	15.3910.871H			203 x 189 x 75	7420903745
	15.3910.872H			203 x 189 x 75	7420903746
	11.3900.100H			371 x 244 x 80	7420903880
	11.3910.110H			303 x 244 x 75	7420903882
	11.3910.120H			303 x 244 x 75	7420903883

1033	II E9 024559			INTEGR.
	IV E9 024559			

	Beschreibung description descripção descripziune descripção benamning Popis оригинал üzeylik leirás opis		mm	OE

19.1033.001.199		a	365 x 200	7482408450
19.1033.002.199		b	201 x 191	7482408451

Renault Midlum
Premium Distribution 05/2006 - 09/2013
Kerax
Renault D-Serie 10/2013 - 01/2024
C-Serie (2,3m)
Renault Premium Route 10/2005 - 09/2023



Premium Route



RENAULT

1000

NEW

II (E) 021108
IV (E) 021109



ABS

INTEGR.



Beschreibung
description
description
description
description
description
opis
ovirecavne
betelisk
letras
opis



OE

59.1000.611.199		24 V kurz short	1	890 x 439 x 180	7424680566
59.1000.612.199		24 V kurz short	1	890 x 441 x 180	7424680570
59.1000.613.199		24 V kurz short	1	890 x 439 x 180	7424680572
59.1000.614.199		24 V kurz short	1	890 x 441 x 180	7424680575
59.1000.641.199		24 V mittel medium	1	890 x 490 x 180	7424680579
59.1000.642.199		24 V mittel medium	1	890 x 483 x 180	7424680584
59.1000.621.199		24 V lang long	1	890 x 539 x 180	7424680595
59.1000.622.199		24 V lang long	1	890 x 530 x 180	7424680600
59.1000.623.199		24 V lang long	1	890 x 539 x 180	7424680606
59.1000.624.199		24 V lang long	1	890 x 530 x 180	7424680610
58.1000.611.199		1 kurz short	1	890 x 439 x 28 ø	7424384079
58.1000.612.199		1 kurz short	1	890 x 441 x 28 ø	7424384933
58.1000.613.199		1 kurz short	1	890 x 439 x 28 ø	7424384963
58.1000.614.199		1 kurz short	1	890 x 441 x 28 ø	7424384872
58.1000.641.199		1 mittel medium	1	890 x 490 x 28 ø	7424384743
58.1000.642.199		1 mittel medium	1	890 x 483 x 28 ø	7424384935
58.1000.621.199		1 lang long	1	890 x 539 x 28 ø	7424384744
58.1000.622.199		1 lang long	1	890 x 530 x 28 ø	7424384936
58.1000.623.199		1 lang long	1	890 x 539 x 28 ø	7424384969
58.1000.624.199		1 lang long	1	890 x 530 x 28 ø	7424384925
61.1000.105.199		9 KIT	9	81 x 76 x 45	7484214269
61.1000.006.199		7 KIT	7	130 x 127 x 65	7423229803
61.1000.007.199		8 KIT 24 V	8	130 x 127 x 65	7423227102
13.1000.601.199		3	3	393 x 210 x 46	7424384063
13.1000.602.199		3	3	393 x 210 x 46	7424384871
13.1000.603.199		5	5	210 x 208 x 54	7424384076
19.1000.601.199		2 24 V 1200	2	387 x 205 x 41	7424384062
19.1000.602.199		2 24 V 1200	2	387 x 205 x 41	7424384748
19.1000.603.199		4 24 V 300	4	205 x 205 x 55	7424384060
20.1000.611.199		6 für for pour	6	519 x 160 x 100	7424382986
20.1000.612.199		6 für for pour	6	519 x 160 x 100	7424486092
20.1000.613.199		6 für for pour t. sensor	6	519 x 160 x 100	7424486090
20.1000.614.199		6 für for pour t. sensor	6	519 x 160 x 100	7424382989
09.1000.400.199		temperature sensor		215	7424384873

Renault D-Serie
E-Tech D
01/2024

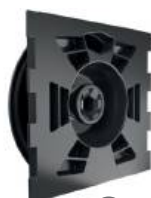
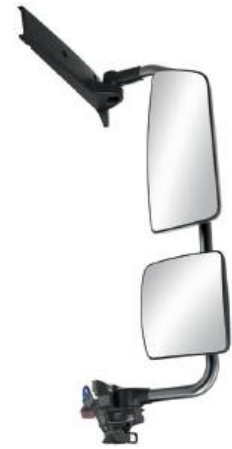

RENAULT

Premium Route 2711 10/05 - 09/13
 Midlum 1818 05/06 - 09/13
 Premium Distribution 05/06 - 09/13
 Kerax 10/13
 D-Serie 10/13
 C-Serie (2,3 m)

RENAULT

552-1	V VI 03★0033 V VI 020894		INTEGR.
	Beschreibung description descripção descripziõe descripciòn benamning popis omicaawe üzellik leirás opis		
59.5524.648.099	1	725 x 319 x 126	7420849837 + 7482226025
51.5524.930H	300	316 x 186 x 77	7421020285
59.5524.649.099	2	437 x 319 x 103	7420849835 + 7482226027
51.5524.930H	300	316 x 186 x 77	7421020285



1
Standard roof







2
High roof







Premium, Gamme R/G 09/2005
 Midlum / Kerax

348	II 03★0184 II 021022		Ø 22 mm
	Beschreibung description descripção descripziõe descripciòn benamning popis omicaawe üzellik leirás opis		
61.3481.149H	1	395 x 205 x 145	5001856290
15.3480.840H	24 V	372 x 189 x 32	
11.3480.100		169 x 88 x 27	
61.3480.149H	2	382 x 193 x 85	5001853675 + 5001856292 5001833026
40.3485.412H	24 V	375 x 190 x 3	



348	IV 03★0185 IV 021023		Ø 22 mm
	Beschreibung description descripção descripziõe descripciòn benamning popis omicaawe üzellik leirás opis		
61.3482.149H	24 V	199 x 199 x 97	7421276373
40.3485.403H	300	191 x 191 x 3	

<h1>RENAULT</h1>				
558	V e1 03★0011 V E1 020912	 		
	Beschreibung description descripțion descripção descripziune benamining popis описанье őzellik leírás opis	 mm	OE	
59.5580.247H		260 x 229 x 70	5010578511	

1025				
V e1 04★1345		 		
	Beschreibung description descripțion descripção descripziune benamining popis описанье őzellik leírás opis	 mm	OE	
59.1025.001.099		315 x 179 x 220	7484531138	
59.1025.002.099		315 x 179 x 220	7484531168	

New Regulation ECE R46/04

*D-Serie
C-Serie (2,3 m)*



10/13
10/13

Original Equipment for the aftermarket

Sichtsysteme für Nutzfahrzeuge



Nur das Original wird kopiert



SCANIA

400				INTEGR.
	Beschreibung description descripção descripziune benamning popsis onwcauwe breilikk leirras opis		OE	
15.4001.840H		432 x 200 x 20	176 5985	
15.4001.740H		184 x 160 x 20	176 7265	

Komplettspiegel erhältlich bei SCANIA
complete mirror available at SCANIA

Serie 4 (NGS)
Serie R/P/T/G



95 - 07/04
08/04 →

08/04 →

Serie 4 R/P/T/G



2016 →

SCANIA

1005	V 04★1336 V 041336			
	Beschreibung description descripção descripziune benamning popsis onwcauwe breilikk leirras opis		OE	
59.1005.003.099		326 x 202 x 214	2382791	

New Regulation ECE R46/04

Serie L/P/G



2016 →

1019	II 041391 IV 041392			
	Beschreibung description descripção descripziune benamning popsis onwcauwe breilikk leirras opis		OE	
19.1019.013.099		400 x 208 x 29	2116845	
19.1019.014.099		400 x 208 x 29	2116846	
19.1019.313.099		219 x 196 x 39	2116848	
19.1019.314.099		219 x 196 x 39	2116849	

1020	V 041389			INTEGR.
	Beschreibung description descripção descripziune benamning popsis onwcauwe breilikk leirras opis		OE	
56.1020.020.099		307 x 279 x 95	2116023	
19.1020.213.099		297 x 172 x 62	2249381	
19.1020.613.099		297 x 172 x 62	2249382	
12.1020.003.099		191 x 137 x 41	2118477	
08.1024.124.099		130 x 120 x 45	3139595	

Serie L/P/G



F7, F10, F12
12/77 - 08/85



250		II 01★14002				Ø 14-20 mm
MEKRA LANG Group		Beschreibung description descripção descrizione description benamning popis omicaune üzellik leirás opis		mm		OE
51.2500.127H		375 x 183 x 26	1581 550			
40.2500.222H		366 x 176 x 3	1581 599			
51.2500.147H		375 x 183 x 26	1594 412 ♦ 1581 616 1594 411			
40.2500.422H		366 x 176 x 3	1581 602 ♦ 1594 415			
09.2070.101H		2070 x 9ø	2108 3541			

FL4, FL6, FL7, FL10
F10, F12, F16
NL10, NL12
09/85 - 9/94
09/85 - 9/93
1972 - 8/85



252		II 02★14089 II 0114089				Ø 14-20 mm
MEKRA LANG Group		Beschreibung description descripção descrizione description benamning popis omicaune üzellik leirás opis		mm		OE
51.2520.127H		444 x 208 x 84	1599 462 ♦ 3090 395			
40.2520.222H		429 x 194 x 3	1697 007 ♦ 2085 4576			
51.2520.147H		444 x 208 x 84	1594 902 ♦ 1621 353 1195 934 ♦ 3090 396			
40.2520.422H		429 x 194 x 3	1697 008 ♦ 3093 519			
09.2070.101H		2070 x 9ø	2108 3541			

FH
FM
NH
10/93 - 03/02
08/98 - 03/02
05/99



370 371		II 02★14125 II 0114125				INTEGR.
MEKRA LANG Group		Beschreibung description descripção descrizione description benamning popis omicaune üzellik leirás opis		mm		OE
15.3702.470H		433 x 198 x 16	3090 737 ♦ 3091 756 3092 854 ♦ 2085 4564			

FH I + FH II
FM I + FM II
1
2



360 360-1		V 02★12013 V 0112013 V 03★0039 V 020973				
MEKRA LANG Group		Beschreibung description descripção descrizione description benamning popis omicaune üzellik leirás opis		mm		OE
59.3601.128H		284 x 174 x 62	1096 643			
40.3605.204F		272 x 162 x 3	3090 734 ♦ 2085 4583			
59.3601.178H		284 x 174 x 64	2120 3313			
40.3605.203H		272 x 162 x 3				
59.3601.188H		284 x 174 x 64				
40.3605.403H		272 x 162 x 3				
59.3602.128H		284 x 174 x 62	3126 117			
40.3605.204F		272 x 162 x 3	3090 734 ♦ 2085 4583			

VOLVO

390	II (E) 021108			Ø 28 mm
	II (E) 03★0242			
	IV (E) 021109			
	IV (E) 03★0243			

MEKRA LANG Group	Beschreibung description description description benämning popis описување leirás opis				mm	OE
	kurz short	lang long	24 V 1200	24 V 300		
58.3900.143H		kurz short			800 x 270	20903722
58.3900.243H		kurz short			800 x 270	20903727
58.3900.133H		lang long			800 x 350	20903723
58.3900.233H		lang long			800 x 350	20903732
58.3900.333H		lang long			800 x 350	20914934
58.3900.433H		lang long			800 x 350	20914938
15.3900.840H			24 V 1200		337 x 202 x 25	20862795
15.3911.871H			24 V 300		200 x 197 x 75	20862810
15.3911.872H			24 V 300		200 x 197 x 75	20862815
61.3900.100H				2	373 x 245 x 101	20862782
61.3900.110H				2	373 x 245 x 101	20866665
61.3900.130H		für for pour		2	373 x 245 x 101	85120820
61.3911.110H				1	245 x 236 x 105	20862809
61.3911.120H				1	245 x 236 x 105	20862813
11.3900.200H					371 x 244 x 80	20862779
11.3910.200H					244 x 225 x 75	20862800
08.5752.024.099					130 x 120 x 53	21618499
20.3900.510H		für for pour			518 x 160 x 98	20708110
20.3900.520H		für for pour			518 x 160 x 98	20708230

09/2006 - 01/2024
FL / FE

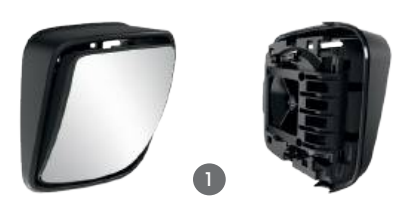

VOLVO

552-1	V VI (E1) 03★0033			INTEGR.
	V VI (E1) 020894			

MEKRA LANG Group	Beschreibung description description description benämning popis описување leirás opis				mm	OE
	300					
59.5524.648.099					725 x 319 x 126	2084 9837
51.5524.930H		300			316 x 186 x 77	2102 0285



01/2024 →
Volvo FL/FE

VOLVO

1000	NEW	II (E) 021108 IV (E) 021109			INTEGR.
-------------	------------	--------------------------------	--	--	----------------

Beschreibung
description
descripção
descricao
benámenning
pops
omrcauwe
bœrellik
reírás
opís

mm

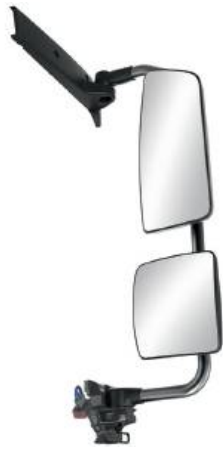

59.1000.611.199		kurz short	890 x 439 x 180	24680566
59.1000.612.199		kurz short	890 x 441 x 180	24680570
59.1000.613.199		kurz short	890 x 439 x 180	24680572
59.1000.614.199		kurz short	890 x 441 x 180	24680575
59.1000.641.199		mittel medium	890 x 490 x 180	24680579
59.1000.642.199		mittel medium	890 x 483 x 180	24680584
59.1000.621.199		lang long	890 x 539 x 180	24680595
59.1000.622.199		lang long	890 x 530 x 180	24680600
59.1000.623.199		lang long	890 x 539 x 180	24680606
59.1000.624.199		lang long	890 x 530 x 180	24680610
58.1000.611.199		kurz short	890 x 439 x 28 ø	24384079
58.1000.612.199		kurz short	890 x 441 x 28 ø	24384933
58.1000.613.199		kurz short	890 x 439 x 28 ø	24384963
58.1000.614.199		kurz short	890 x 441 x 28 ø	24384872
58.1000.641.199		mittel medium	890 x 490 x 28 ø	24384743
58.1000.642.199		mittel medium	890 x 483 x 28 ø	24384935
58.1000.621.199		lang long	890 x 539 x 28 ø	24384744
58.1000.622.199		lang long	890 x 530 x 28 ø	24384936
58.1000.623.199		lang long	890 x 539 x 28 ø	24384969
58.1000.624.199		lang long	890 x 530 x 28 ø	24384925
61.1000.105.199		KIT	81 x 76 x 45	84214269
61.1000.006.199		KIT	130 x 127 x 65	23229803
61.1000.007.199		KIT 24 V	130 x 127 x 65	
13.1000.601.199			393 x 210 x 46	24384063
13.1000.602.199			393 x 210 x 46	24384871
13.1000.603.199			210 x 208 x 54	24384076
19.1000.601.199		24 V 1200	387 x 205 x 41	24384062
19.1000.602.199		24 V 1200	387 x 205 x 41	24384748
19.1000.603.199		24 V 300	205 x 205 x 55	24384060
20.1000.611.199		für for pour	519 x 160 x 100	24382986
20.1000.612.199		für for pour	519 x 160 x 100	24486092
20.1000.613.199		für for pour t. sensor	519 x 160 x 100	24486090
20.1000.614.199		für for pour t. sensor	519 x 160 x 100	24382989
09.1000.400.199		temperature sensor	215	24384873

VOLVO

1000 1043/1044	II ☎ 041541	II ☎ 021108			INTEGR.
	IV ☎ 041540	IV ☎ 03★0242			

	Beschreibung description description description benamining pops описание birelik letras opis		mm	
--	--	--	----	--

51.1043.001.099		a	413 x 203 x 75	OE offers only components	MEKRA
51.1043.002.099		a	413 x 203 x 75	OE offers only components	
51.1044.001.099		b	204 x 209 x 88	OE offers only components	
51.1044.002.099		b	204 x 209 x 88	OE offers only components	
09.1000.200.099		1	250		
19.1043.001.099		a	406 x 199 x 40		OE
19.1044.001.099		b	199 x 204 x 54		
13.1043.001.000		a	413 x 203 x 47		
13.1044.001.000		b	204 x 209 x 54		
19.1000.101.099		c	387 x 205 x 41	82356810	
19.1000.121.099		2 c	387 x 205 x 41	24015370	
19.1000.102.099		d	387 x 205 x 41	82359214	
19.1000.122.099		2 d	387 x 205 x 41	24015373	
19.1000.103.099		e	205 x 205 x 55	82356824	
61.1000.004.099			130 x 127 x 65	23227102	

1 Anschlusskabel (Austausch) für Heizung ab Bj. 05/2019
heating cable for replacement for vehicles from 05/2019



VOLVO FH 4
VOLVO FMX
VOLVO FMD

10/12
10/15
2020

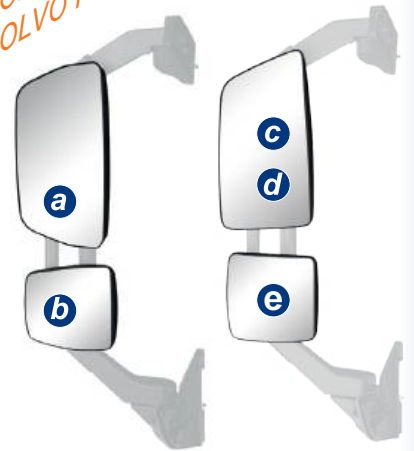

MEKRA OE



Das Blind Spot Modul ist im Lieferumfang nicht enthalten!
The Blind Spot Modul is not included in the delivery!

FL/FE



09/06

New Regulation ECE R46/04

VOLVO			
1025	V \square 1 04★1345	Truck \square V	ABS
MEKRA LANG Group		mm	
Beschreibung description descrição descripzione benämning popis omicaune üzellik leirás opis		OE	
59.1025.001.099		315 x 179 x 220	8453 1138
59.1025.002.099		315 x 179 x 220	8453 1168

FH2 / FM2



04/02 - 09/2012

224		Truck \square II + IV	ABS	INTEGR.
MEKRA LANG Group		mm		OE
Beschreibung description descrição descripzione benämning popis omicaune üzellik leirás opis				
15.2240.840H		431 x 197 x 30	2056 7670 + 2132 0383	

Komplettspiegel erhältlich bei VOLVO
complete mirror available at VOLVO

10/10 - 12/2015

FMX



572	II \square 1 03★0031 II \square 1 020918	Truck \square II	ASA	Ø 22 / 28 mm
MEKRA LANG Group		mm		OE
Beschreibung description descrição descripzione benämning popis omicaune üzellik leirás opis				
61.5721.006.099		426 x 200 x 135	8247 1690	
61.5721.005.099		426 x 200 x 135	8247 1688	
40.5725.412H		412 x 188 x 3	8241 7041	
61.5721.004.099		78 x 69 x 38	8247 2612	
11.5721.001.099		427 x 199 x 36	8241 7042	
08.5380.004.000		72 x 75 x 36		



573	IV \square 1 03★0032 IV \square 1 020917	Truck \square IV	ASA	Ø 22 / 28 mm
MEKRA LANG Group		mm		OE
Beschreibung description descrição descripzione benämning popis omicaune üzellik leirás opis				
61.5731.001.099		202 x 198 x 126	8247 1689	
40.5735.403H		190 x 184 x 3	8241 7044	
61.5721.004.099		78 x 69 x 38	8247 2612	
11.5731.001.099		202 x 198 x 27	8241 7045	

01/96



349 349 TW	II e1 02★0384 II (E1) 010384			INTEGR.
-----------------------------	---------------------------------	--	--	----------------

	Beschreibung description descripción descrizione benámening popis özetleírás opis		OE
--	--	--	-----------

15.3491.071H		238 x 142 x 6	2D0 857 521	1
15.3491.072H		238 x 142 x 6	2D0 857 522	
51.3495.112H		283 x 295 x 80	2D1 857 501 C 01C	
15.3491.371H		238 x 142 x 6	2D0 857 521 A	
15.3491.372H		238 x 142 x 6	2D0 857 522 A	
56.3491.110H		175 x 116 x 70		2
15.2711.214H		165 x 93 x 15		
56.3492.110H		175 x 116 x 70		
15.2711.214H		165 x 93 x 15		

LT



Volkswagen
LT (Crafter) 05/2006 - 02/2017



589	II III e1 03★0006 II III E1 020902		ABS	INTEGR.
------------	---------------------------------------	---	-----	---------



mm









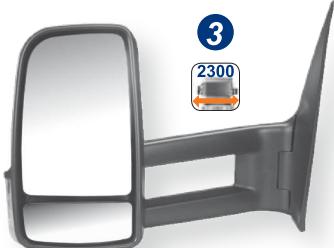









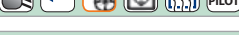

























* mit beheizter Weitwinkel - Glaseinheit, nur verwendbar für Fahrzeuge ab "EURO 5" with heated wide angle mirror glass unit, suitable from "EURO 5" vehicles only



		Beschreibung description description description benamning popsis ömrcauwe ბრელიკ reírás opis			
L H D	1	51.5891.111.199		344 x 315 x 182 2E1 857 501 E 2E1 857 501 AJ	
		51.5891.112.199 *		344 x 315 x 182 2E1 857 501 Q	
		51.5891.113.199		344 x 315 x 182 2E1 857 501 F	
		51.5891.114.199 *		344 x 315 x 182 2E3 857 501 J	
		51.5894.112.199 *		344 x 315 x 182 2E0 857 513 C	
	R H D		51.5891.311.199		344 x 345 x 182 2E2 857 501 C 2E2 857 501 N
			51.5894.310.199		344 x 345 x 182 2E0 857 513 B
			51.5891.312.199 *		344 x 345 x 182 2E2 857 501 F
			51.5891.313.199		344 x 345 x 182 2E2 857 501 D
		51.5891.314.199 *		344 x 345 x 182 2E4 857 501 K	
L H D		51.5891.211.199		344 x 345 x 182 2E1 857 502 E 2E1 857 502 AK	
		51.5891.212.199 *		344 x 345 x 182 2E1 857 502 P	
		51.5891.213.199		344 x 345 x 182 2E1 857 502 F	
		51.5891.214.199 *		344 x 345 x 182 2E3 857 502 K	
		51.5894.212.199 *		344 x 345 x 182 2E0 857 514 B	
	R H D		51.5891.411.199		344 x 315 x 182 2E2 857 502 C 2E2 857 502 N
		51.5894.410.199		344 x 315 x 182 2E0 857 514 A	
		51.5891.412.199 *		344 x 315 x 182 2E2 857 502 F	
		51.5891.413.199		344 x 315 x 182 2E2 857 502 D	
		51.5891.414.199 *		344 x 315 x 182 2E4 857 502 L	
L H D	2	51.5892.111.199		344 x 509 x 182 2E3 857 501 D 2E1 857 501 AK	
		51.5892.112.199 *		344 x 509 x 182 2E1 857 501 R	
		51.5892.113.199		344 x 509 x 182 2E3 857 501 F	
	R H D		51.5892.311.199		344 x 460 x 182 2E4 857 501 D 2E4 857 501 AD
			51.5892.312.199 *		344 x 460 x 182 2E2 857 501 G
			51.5892.313.199		344 x 460 x 182 2E4 857 501 F
	51.5895.312.199 *		344 x 460 x 182 2E4 857 513 B		
L H D		51.5892.211.199		344 x 460 x 182 2E1 857 502 D 2E1 857 502 AL	
		51.5892.212.199 *		344 x 460 x 182 2E1 857 502 Q	
		51.5892.213.199		344 x 460 x 182 2E3 857 502 F	
R H D		51.5892.411.199		344 x 509 x 182 2E4 857 502 E	
		51.5892.413.199		344 x 509 x 182 2E4 857 502 G	
		51.5895.412.199 *		344 x 509 x 182 2E4 857 514 B	
L H D	3	51.5893.111.199		344 x 543 x 182 2E3 857 501 E 2E1 857 501 AL	
		51.5893.112.199 *		344 x 543 x 182 2E3 857 501 H	
		51.5893.113.199		344 x 543 x 182 2E3 857 501 G	
		51.5893.211.199		344 x 511 x 182 2E3 857 502 E 2E1 857 502 AM	
		51.5893.212.199 *		344 x 511 x 182 2E3 857 502 J	
		51.5893.213.199		344 x 511 x 182 2E3 857 502 G	



589	II III e1 03★0006	II III
	II III E1 020902	II III

MEKRA LANG Group	Beschreibung description descripção descrizione description benamning Popis omírcauwe birellik letralis opis	mm	OE
------------------	--	----	----

15.5891.741H		236 x 155 x 16	2E1 857 587	a
15.5891.742H		236 x 155 x 16	2E1 857 588	
15.5891.611H		154 x 59 x 19	2E1 857 587 A	b
15.5891.612H		154 x 59 x 19	2E1 857 588 A	
19.5890.011.099		240 x 158 x 21	2E0 857 587 A	c
19.5890.012.099		240 x 158 x 21	2E0 857 588 A	
19.5891.011.099		240 x 158 x 21	2E0 857 587 B	
19.5891.012.099		240 x 158 x 21	2E0 857 588 B	
08.5890.300.099		113 x 32 x 15	2E0 919 473	
08.5890.301.099		113 x 32 x 15	2E0 919 473 A	
15.5891.721.099		157 x 65 x 20	2E1 857 587 E	d
15.5891.722.099		157 x 65 x 20	2E1 857 588 E	
13.5890.110.199		344 x 218 x 82	2E1 857 516 A	
13.5890.210.199		344 x 218 x 82	2E1 857 516 B	
13.5890.120.099		344 x 201 x 82	2E0 857 527	
13.5890.220.099		344 x 201 x 82	2E0 857 528	
14.5890.100.099		337 x 192 x 56	2E1 857 136	
14.5890.200.099		337 x 192 x 56	2E1 857 136 A	
08.5892.001.099		133 x 118 x 88	2E0 953 049 A + 2E0 945 981	13
08.5892.002.099		133 x 118 x 88	2E0 953 049 C + 2E0 945 981	13
08.5892.003.099		133 x 118 x 88	2E0 953 050 A or 2E0 953 050 C + 2E0 945 981	13
08.5892.004.099		133 x 118 x 88	2E0 953 050 B or 2E0 953 049 B + 2E0 945 981	13
08.5892.105.099		51 x 27 ø	2E0 945 981	12

05/06 - 09/09

Volkswagen
LT (Crafter)



a



b

10/2009

Volkswagen
LT (Crafter) EURO 5 + 6



c



d



VW

Volkswagen NF (Crafter) 08/2017



1013	NEW	II (E1) 041427			INTEGR.
-------------	------------	----------------	---	---	----------------























Beschreibung
description
descripção
descripziõe
benamining
popsis
omicaame
bœeilik
letrās
opis







	L H D	R H D				
1	59.1013.116.199		384 x 330 x 257	7C1857387FP * 7C1857387ES	5, 14, 16, 20, 23, 24, 27	*
	59.1013.117.199		384 x 330 x 257	7C1857387FJ * 7C1857387FC	1, 5, 12, 14, 16, 20, 23, 24, 25, 27	*
	59.1013.216.199		384 x 309 x 314	7C1857388EG * 7C1857388DK	6, 15, 17, 21, 22, 24, 25, 29	*
	59.1013.101.199		384 x 330 x 257	7C1857387FT * 7C1857387ET	4, 5, 14, 16, 18, 23, 27	*
	59.1013.109.199		384 x 330 x 257	7C1857387FK * 7C1857387FD	1, 4, 5, 12, 14, 16, 18, 23, 27	*
	59.1013.201.199		384 x 309 x 314	7C1857388EH * 7C1857388DL	4, 6, 15, 17, 19, 22, 25, 29	*
	59.1013.212.199		384 x 309 x 314	7C1857388EC * 7C1857388DQ	2, 3, 4, 6, 13, 15, 17, 19, 22, 25, 29	*
	59.1013.102.199		384 x 330 x 257	7C1857387FR * 7C1857387FB	4, 5, 14, 16, 18, 23, 26	*
	59.1013.106.199		384 x 330 x 257	7C1857387FM * 7C1857387FF	1, 4, 5, 12, 14, 16, 18, 23, 26	*
	59.1013.202.199		384 x 309 x 314	7C1857388EK * 7C1857388DN	4, 6, 15, 17, 19, 22, 25, 28	*
	59.1013.316.199		384 x 309 x 314	7C2857387CR * 7C2857387CG	10, 14, 16, 20, 23, 24, 25, 30	*
	59.1013.317.199		384 x 309 x 314	7C2857387CN * 7C2857387CJ	1, 10, 12, 14, 16, 20, 23, 24, 25, 30	*
	59.1013.416.199		384 x 330 x 257	7C2857388CB * 7C2857388BL	11, 15, 17, 21, 22, 24, 25, 31	*
	59.1013.301.199		384 x 309 x 314	7C2857387CS * 7C2857387CH	4, 10, 14, 16, 18, 23, 25, 30	*
	59.1013.309.199		384 x 309 x 314	7C2857387CP * 7C2857387CK	1, 4, 10, 12, 14, 16, 18, 23, 25, 30	*
	59.1013.401.199		384 x 330 x 257	7C2857388CC * 7C2857388BM	4, 11, 15, 17, 19, 22, 25, 31	*
	59.1013.412.199		384 x 330 x 257	7C2857388BT * 7C2857388BP	2, 3, 4, 11, 13, 15, 17, 19, 22, 25, 31	*
2	59.1013.501.199		384 x 434 x 191	7CB857387BE v 7CB857387BA	4, 5, 14, 16, 18, 23, 25, 32	*
	59.1013.509.199		384 x 434 x 191	7CB857387BC v 7CB857387AT	4, 5, 7, 12, 14, 16, 18, 23, 25, 32	*
	59.1013.601.199		384 x 434 x 238	7CB857388AL v 7CB857388AJ	4, 6, 15, 17, 19, 22, 25, 33	*
	59.1013.612.199		384 x 434 x 238	7CB857388AN v 7CB857388AG	4, 6, 8, 9, 13, 15, 17, 19, 22, 25, 33	*

* Der Komplettspiegel besteht aus den aufgelisteten Positionen.
 Die Zuordnung zu den entsprechenden Artikelnummern befindet sich auf der rechten Seite.
 The complete mirror consists of the items listed.
 The allocation to the corresponding article number is on the right-hand side.

VW

1013	NEW	II (E1) 041427			INTEGR.
		Beschreibung description description description benamining Pops описание birelik leirats opis		 mm	OE
19.1013.011.099			211 x 169 x 19	7C0 857 521 D 7C0 857 521 G	
19.1013.012.099			211 x 169 x 19	7C0 857 522 A 7C0 857 522 F	

Volkswagen NF (Crafter) 2017



Pos.	MEKRA	VW	Icons: FM, LTE, GNSS, etc.	Rumpfspiegel - carcass
1	08.1013.007.000	7C0 035 532		
2	08.1013.008.000	7C0 035 534		
3	08.1013.009.000	7C0 035 540		
4	08.1013.010.000	7C0 959 578		
5	08.1013.012.100	7C1 949 101 B		
6	08.1013.013.100	7C1 949 102 B		
7	08.1013.107.000	7C0 035 532 A		
8	08.1013.108.000	7C0 035 534 A		
9	08.1013.109.000	7C0 035 540 A		
10	08.1013.712.100	7C2 949 101 B		
11	08.1013.713.100	7C2 949 102 B		
12	11.1013.015.000	7C0 035 981		
13	11.1013.016.000	7C0 035 981 A		
14	13.1013.001.000	7C0 857 527		
15	13.1013.002.000	7C0 857 528		
16	13.1013.003.000	7C0 857 603 A		
17	13.1013.004.000	7C0 857 604 A		
18	19.1013.011.004	7C0 857 521 G		
19	19.1013.012.004	7C0 857 522 F		
20	19.1013.411.004	7C0 857 521 F		
21	19.1013.412.004	7C0 857 522 E		
22	61.1013.002.004	7C0 898 554		
23	61.1013.003.004	7C0 898 553		
24	61.1013.001.004	2E0 857 049		
25	61.1013.005.004	7C0 898 011		
26	61.1013.103.004	7C1 857 407 L		
27	61.1013.116.004	7C1 857 407 J		
28	61.1013.203.004	7C1 857 408 L		
29	61.1013.216.004	7C1 857 408 J		
30	61.1013.316.004	7C2 857 407 G		
31	61.1013.416.004	7C2 857 408 G		
32	61.1013.501.004	7CB 857 407 C		
33	61.1013.601.004	7CB 857 408 C		

UNIVERSAL

Agriculture
Case New Holland, Fendt,
John Deere, Kässbohrer, KFB etc.



*
Variante mit 2 Steckern für beheizbare Zusatzspiegel
version with 2 plug sockets for mounting additional heated mirrors

385		II e1 02★0469 I (E1) 010469		Truck II ABS		① Ø 14-20 mm ② Ø 20-30 mm	
MEKRA LANG Group		Beschreibung description descripção descripzione benämning popis omicaune üzellik leirás opis		mm		OE	
51.3850.127H						314 x 228 x 65	G 297.810.150.030 (Fendt) AL 158964 (John Deere)
51.3850.227						314 x 228 x 65	00437650 (Case New Holland)
40.2890.222H						300 x 214 x 3	F 297 810 150 010 (Fendt)
51.3850.137						314 x 228 x 65	
40.2890.322						300 x 214 x 3	
10.6211.100						282 x 162	
09.2000.301H						2000 x 9 ø	
51.3850.147H						314 x 228 x 65	Y07001023 (KFB) HJ24013370 (VDL)
51.3850.247						314 x 228 x 65	8.688.100.000.0 (Kässbohrer)
40.2890.422H						300 x 214 x 3	
10.6221.100						282 x 162	
09.2000.301H						2000 x 9 ø	
51.3850.157						314 x 228 x 65	
40.2890.322						300 x 214 x 3	
10.6211.100						282 x 162	
51.3850.167H						314 x 228 x 65	D072143 (Bredamenarini)
51.3850.197H *						314 x 228 x 65	2097 0652 (Volvo)
51.3850.267						314 x 228 x 65	33.63730-6001 (MAN) D072143 (Bredamenarini)
40.2890.422H						300 x 214 x 3	
10.6221.100						282 x 162	001 821 00 29 (Mercedes) 8.688.041.029.0 (Setra) 1905 564 00 (Neoplan) 161.00.77.2027 (MAN Steyr)
09.3400.420						2000	

UNIVERSAL
universal Rampenspiegel

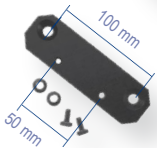

552-1		V VI e1 03★0033 V VI (E1) 020894		Truck V ABS			
MEKRA LANG Group		Beschreibung description descripção descripzione benämning popis omicaune üzellik leirás opis		mm		OE	
59.5520.530H						319 x 187 x 77	1525 537 (DAF) 105137C (Plaxton)

UNIVERSAL

300				① Ø 30 mm ② Ø 35 mm
	Beschreibung description descripção descripzione benamning popis описання őzellék leírás opis			
55.3000.005.001				Ø 306 x 96
55.3000.002.001				Ø 306 x 88
55.3000.004.001				Ø 306 x 88
51.3000.003.001				Ø 306 x 96
51.3000.002.001				Ø 306 x 88 2401 8790 (Volvo) 3070159 (SCANIA)
61.3000.003.010				47 x 48 x 260
61.3000.004.010				47 x 48 x 260 2401 8822 (Volvo) 3070160 (SCANIA)

Innenspiegel Busse
EvoBus, Göppel, Hess, Neoplan,
Scania, VDL, Volvo



750				INTEGR.
	Beschreibung description descripção descripzione benamning popis описання őzellék leírás opis			
51.7504.044.001				301 x 141 2320 0690 (Volvo)
20.7504.044.001				230 2328 6290 (Volvo)
20.7504.003.001				71 2328 6294 (Volvo)

Innenspiegel



552-1	V VI 03★0033 V VI 020894			INTEGR.
	Beschreibung description descripção descripzione benamning popis описання őzellék leírás opis			
59.5524.530H				418 x 492 x 77 27230912 (Terex)
51.5524.930H				316 x 186 x 77

universal Frontspiegel



389	VI 03★0016 VI 020937			INTEGR.
	Beschreibung description descripção descripzione benamning popis описання őzellék leírás opis			
59.3891.140H				397 x 557 x 92
51.3894.140H				Ø 259 x 92



Montagevarianten
mounting possibilities
possibilités de montage
possibilidades de montagem
variante del montaggio
possibilidades de montaje
monteringsmögijgheter
Montážní varianty
Виды монтажа
montaj montaj olasılikları
különböző kivitelek
Możliwości montażu

A Dach
roof
pavillon
teto
tetto
techo
tak
střecha automobilu
Крышы автомобиля
kabin üstü
tetöre szerelt
Dach

B A-Säule
A-pillar
montant
pilar A
pilastro A
pilar A
A - stolpe
A - sloupek
A - obr. stolb
A - sütunu
A oszlopra szerelt
Stupek

diverse Traktoren / various tractors



*Steyr Trucks
Steyr- + KHD Traktoren*



DEMAG, Caterpillar



passend für • fitting for • approprié pour • para • adatto per • para • passar • vhodné pro • подходит для • kullanylabilinir • alkalmas • pasuje do

UNIVERSAL AGRICULTURE

152 ASKB	II 14010			Ø 10 / 12 / 13 mm
	Beschreibung description descripção descripziõe benämning popis omicaawe bzeilikk leirras opis			
51.1524.119H		260 x 149 x 22	E 178.810.150.019 (Fendt) E 178.810.150.010 (Fendt) F 178.810.150.020 (Fendt) 000 811 68 33 (Mercedes) 639 153 (Scania)	
40.1525.114H		252 x 141 x 3		

289				Ø 16-18 mm
	Beschreibung description descripção descripziõe benämning popis omicaawe bzeilikk leirras opis			
51.2890.117H		310 x 220 x 25	G 816.810.150.030 (Fendt) 161 0077 0103 (MAN Steyr) 81.63730-6170 (MAN)	
40.2890.222H		300 x 214 x 3	F 297 810 150 010 (Fendt)	
51.2890.147H		310 x 220 x 25		
40.2890.422H		300 x 214 x 3		
10.6221.100		282 x 162		
09.2070.101H		2070 x 9Ø	10342167 (Liebherr) 11182172 (Liebherr)	

363	II 03★0022 II 020905			Ø 18-28 mm
	Beschreibung description descripção descripziõe benämning popis omicaawe bzeilikk leirras opis			
51.3635.201		384 x 205 x 120	290-5544 (Caterpillar) 319-6789 (Caterpillar) 270011780 (Krone)	
51.3636.201		384 x 205 x 120	290-5545 (Caterpillar) 319-6788 (Caterpillar)	
51.3635.204		384 x 205 x 120	294-1991 (Caterpillar) 316-6791 (Caterpillar)	
51.3636.204		384 x 205 x 120	294-1992 (Caterpillar) 319-6790 (Caterpillar)	
15.3802.840H		368 x 189 x 40	8.688.105.263.0 (Kässbohrer) 11312890 (Krauss-Maffei) 10470601 (Liebherr) AP105367C-3 (Plaxton) 990115703000 (Tatra) 48092012 (Terex)	
51.3635.206		384 x 205 x 120	688 645 (Fritzmeier) 8.688.105.000.0 (Kässbohrer) 443332051000 (Tatra)	
51.3636.206		384 x 205 x 120	688 646 (Fritzmeier) 8.688.106.000.0 (Kässbohrer) 443332052000 (Tatra)	
15.3802.840H		368 x 189 x 40	<i>siehe oben / see above</i>	
11.3730.210H		367 x 187 x 60	84434473 (CNH)	

UNIVERSAL AGRICULTURE

1009	II (E1) 021165		Ø 18-22 mm Ø 28 mm *
-------------	----------------	--	-------------------------

<div style="font-size: 8px; line-height: 1.2;"> Beschreibung description descriþiþo descrizione descriþiþion þþþþþþþþþþ þþþþþþþþþþ þþþþþþþþþþ þþþþþþþþþþ þþþþþþþþþþ þþþþþþþþþþ þþþþþþþþþþ </div>	mm	OE
---	----	----

51.1009.017.099		382 x 232 x 122	372-8075 (Caterpillar) 26143870 (Class) G304810150020 (Fendt) ACV0805960 (Fendt/Valtra) 42154H3480 (Komatsu) 21D-54-41710 (Komatsu) 1000386860 (Kramer) 11068341 (Liebherr) 3010662 (Lindner) 17452496 (Volvo)	1
51.1009.027.099		382 x 232 x 122	436-2886 (Caterpillar)	
51.1009.149.099		382 x 232 x 122	1000390196 (Kramer) 11181691 (Liebherr) 21971360 (Claas)	
51.1009.097.099		382 x 232 x 122	1000396281 (Kramer) ACV0148490 (Valtra) 3728076-03 (Carwall) ACV0148490 (Fendt) 42154H3380 (Komatsu) 16281990 (Volvo)	
51.1009.025.099		382 x 232 x 122		
51.1009.045.001		382 x 232 x 122		
51.1009.047.001		382 x 232 x 122		
51.1009.021.099		465 x 231 x 143	26095630 (Claas) G743810150010 (Fendt) 3010850 (Lindner) G743810150020 (Fendt) 26096000 (Claas) 1000379630 (Kramer) 3010851 (Lindner)	2
51.1009.022.099		465 x 231 x 143		
51.1009.121.099		465 x 231 x 143	3010852 (Lindner)	
51.1009.122.099		465 x 231 x 143	1000379641 (Kramer) 3010853 (Lindner)	
51.1009.242.099		Ø 28 mm	436-2887 (Caterpillar)	3
09.2000.301H		2000 x 9 Ø	11181692 (Liebherr)	
09.3200.420H		42 x 42 x 54 [2000]	6.200.26.176 (Mauser)	
a 51.1009.001.099		291 x 232 x 121	526-5057 (Caterpillar) 3010115 (Lindner) 2186303 (Wirtgen)	2
51.1009.081.099		291 x 232 x 121	3010188 (Lindner)	
51.1009.113.099		291 x 232 x 121	22332170 (Claas) AKK34593 (John Deere)	
51.1009.009.099		291 x 232 x 121	545541 (Miller)	
40.1009.001.000		285 x 225 x 2	5653634836 (Terex) F743810150010 (Fendt)	3
40.1009.004.099		285 x 225 x 2	ACV0759270 (Fendt/Valtra) 3205677 (Lindner)	
40.1009.001.099		285 x 225 x 2		
b 51.1009.049.099		190 x 109 x 18		d
40.1009.002.000		178 x 92 x 2	5653634837 (Terex) F304810150030 (Fendt)	
40.1009.002.099		178 x 92 x 2	11578550 (Claas) ACV0759280 (Valtra)	
40.1009.005.099		178 x 92 x 2	166352077 (SIAC)	
c 61.1009.001.099		196 x 188 x 42	11654110 (Claas)	3
61.1009.002.099		196 x 188 x 42	11654120 (Claas)	
40.1009.421.002		180 x 170 x 2	F743810150020 (Agco) 11653140 (Claas)	
40.1009.422.002		180 x 170 x 2	F749810150030 (Agco) 11653170 (Claas)	
d 40.1009.003.099		202 x 138 x 3		

Große Traktoren
large tractors

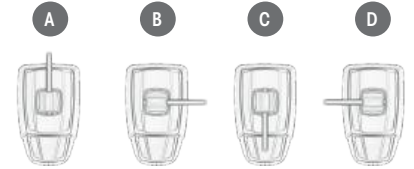

Rohranbindung
mounting position arm



1 Haupt- und Nahbereichsspiegel
Main and close proximity mirror



2 Hauptspiegel mit großen
Nahbereichsspiegel für
Traktoren ISO 5721-2
Main - and large close proximity
mirror for tractors ISO 5721-2



3 Hauptspiegel mit großen
Nahbereichsspiegel für
Radbagger ISO14401-2
Main - and large close proximity
mirror for Wheel excavator
ISO14401-2

UNIVERSAL AGRICULTURE

Kleine Traktoren
small tractors



1010	II (E1) 021228			Ø 14 - 20 mm
	Beschreibung description descripción descricao description benámenning popis opis opis			
51.1010.010.001		284 x 176 x 90	R561145311 (Kubota)	
40.1010.002.099		278 x 169 x 2		

Teleskopstange
telescopic bracket



1017				Ø 22 mm
	Beschreibung description descripción descricao description benámenning popis opis opis			
58.1017.005.099		510 - 800 Teleskop	G-530810150010 (AGCO)	
58.1017.006.099		510 - 800 Teleskop	G-530810150020 (AGCO)	
58.1017.013.099		510 - 800 Teleskop		
58.1017.014.099		510 - 800 Teleskop		
58.1017.011.099		510 - 800 Teleskop	3009961 (Lindner)	
58.1017.012.099		510 - 800 Teleskop	3009999 (Lindner)	
58.1017.015.099		510 - 760 Teleskop		
58.1017.016.099		510 - 760 Teleskop		

UNIVERSAL



1038	NEW	II (E1) 051696			Ø 22 mm
	Beschreibung description descripción descricao description benámenning popis opis opis				
51.1038.003.099		359 x 178 x 89			
51.1038.004.099		359 x 178 x 89			
58.1038.003.099		554 - 804 Teleskop	30331340 (Claas)		
58.1038.004.099		554 - 804 Teleskop	30331350 (Claas)		
a 40.1038.411.099		234 x 166 x 2			
40.1038.412.099		234 x 166 x 2			
b 40.1038.751.099		162 x 125 x 2			
40.1038.752.099		162 x 125 x 2			

Werkzeuglos verstellbar von vertikal zu horizontal
Adjustable from vertical to horizontal without tools

UNIVERSAL AGRICULTURE

1036

II (E1) 041459



Ø 22 mm



Beschreibung
description
descripção
descrizione
description
benamining
popsis
описание
birelik
letras
opts



51.1036.021.099		487 x 228 x 130		1
51.1036.022.099		487 x 228 x 130		
51.1036.023.099		487 x 228 x 130	26079370 (Claas) 47826941 (CNH)	
51.1036.024.099		487 x 228 x 130	26079500 (Claas) 47904843 (CNH)	
51.1036.025.099		487 x 228 x 130	6-200.26.185 (Mauser)	
51.1036.026.099		487 x 228 x 130		
11.1036.011.099		153 x 144 x 45	11617700 (Claas) 51487075 (CHN) R566924 (John Deere)	
11.1036.012.099		153 x 144 x 45	11617720 (Claas) 51487076 (CNH)	
51.1036.007.099		487 x 228 x 130	47922743 (CNH)	2
51.1036.008.099		487 x 228 x 130	47922744 (CNH)	
51.1036.009.099		487 x 228 x 130	47922739 (CNH) AL232743 (John Deere)	
51.1036.010.099		487 x 228 x 130	47922741 (CNH) AL232744 (John Deere)	
11.1036.013.099		153 x 144 x 45	48025212 (CNH) L221136 (John Deere)	
11.1036.014.099		153 x 144 x 45	48025217 (CNH) L221137 (John Deere)	
19.1036.005.099		299 x 202 x 24	48025196 (CNH)	
19.1036.006.099		177 x 190 x 14	48025209 (CNH)	
19.1036.007.099		299 x 202 x 24	11617730 (Claas) 48025195 (CNH) AL225823 (John Deere)	
19.1036.008.099		177 x 190 x 14	11617740 (Claas) 48025204 (CNH) AL225824 (John Deere)	
19.1036.009.099		299 x 202 x 24		
19.1036.010.099		177 x 190 x 14		
09.3200.420H		42 x 42 x 54 [2000]		

Große Traktoren
large tractors



1

Vertikale Rohranbindung
Mounting to vertical tube



2

Horizontale Rohranbindung
Mounting to horizontal tube



UNIVERSAL MOTOR HOMES

BÜRSTNER Grand Panorama 2012
 CARTHAGO Chic 2012
 EURA MOBIL Integra 2012
 CONCORDE, Plaxton, Hymer

1018	II (E1) 021281 IV (E1) 021282			INTEGR.
-------------	----------------------------------	--	--	----------------

	Beschreibung description descripção descrizione description benamning popis omircaune birelik leirás opis		mm	
--	---	--	----	--



1	59.1018.003.099			673 x 245 x 327	284260 (Concorde)
	59.1018.004.099			673 x 245 x 327	284261 (Concorde)
	12.1018.003.099			182 x 64 x 61	
2	59.1018.007.099			699 x 245 x 406	2276379 (Bürstner)
	59.1018.008.099			699 x 245 x 406	207193 (Carthago)
	12.1018.005.099			262 x 64 x 64	
3	59.1018.001.099			727 x 245 x 480	200070726B (Eura Mobil)
	59.1018.002.099			727 x 245 x 480	200070727B (Eura Mobil)
	12.1018.007.099			345 x 64 x 67	2193841 (Bürstner) 201621 / 201622 (Carthago)
	12.1018.001.099			517 x 197 x 70	2193829 (Bürstner) 201619 (Carthago) 2203 3845 (Volvo)
	12.1018.002.099			517 x 197 x 70	2193831 (Bürstner) 201620 (Carthago) 2203 3846 (Volvo)
	15.2780.841F			307 x 177 x 22	8034580 (Hymer)
	19.1018.311.099			178 x 142 x 34	
	19.1018.312.099			178 x 142 x 34	
	12.1018.009.001			226 x 116 x 85	2193839 (Bürstner) 284265 (Concorde) 207195 (Carthago) 175202B-9 (Plaxton)
	12.1018.010.001			226 x 116 x 85	2193840 (Bürstner) 284266 (Concorde) 207196 (Carthago) 175202B-8 (Plaxton)
	09.2910.005.099			3550 x 6 ø	2218519 (Bürstner) 200070749 (Eura Mobil)
	09.2910.002.099			6050 x 6 ø	2218516 (Bürstner) 200070751 (Eura Mobil) 2203 8103 (Volvo)
	08.3200.233H			42 x 42 x 54	200607013 (Bürstner) 112228 (Carthago) 200070818 (Eura Mobil) 1449696 (Hymer) 2092 5244 (Volvo)



a Haltefußabdeckung
cover retaining foot



b Tragarmschale oben
up cover support shaft



c Spiegelkopfabdeckung
mirror head cover

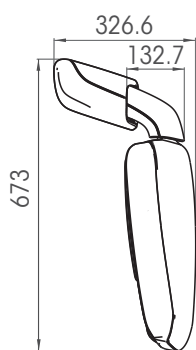

kurz short **1**

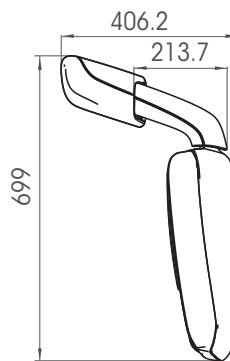

mittel middle **2**

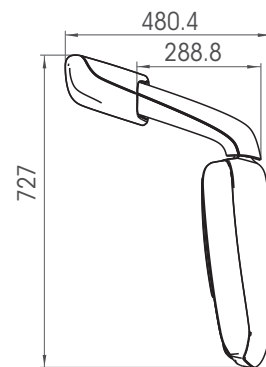

lang long **3**

UNIVERSAL COACHES

271

II e1 02★0524

II (E1) 010524



ABS

PU



Beschreibung
description
description
description
benamining
pops
omicaawe
leirais
oips



OE

59.2710.401H		703 x 783 x 212	1	284230 (Concorde) 53-707213-710401 (Merkavim) AA-01976 (Plaxton) P758200126 (VDL) 8350 042502 * 7032 8278 (Volvo)
51.3731.326		384 x 205 x 116		50.06.232.483 (Irisbus) 17294289-0 (Marcopolo) 53-707127-731326 (Merkavim) PAA-01976-1 (Plaxton) 189 3532 (Scania) 1905 503 00 (Solaris) 30022423 (VDL) 7030 9627 * 8706 2719 00059 (Volvo) 8350 035653 (Volvo)
59.2710.402H		701 x 641 x 200	2	1251 2071 (Carrus) 284232 (Concorde) 53-707213-710402 (Merkavim) 30017729 (VDL) 7302 8283 (Volvo)
51.3732.326		384 x 205 x 116		D072145 (Bredamenarini) 7036 9682 (Carrus) 50.06.232.482 (Irisbus) 17294289-0 (Marcopolo) PAA-01977-1 (Plaxton) 189 5048 (Scania) 1905-502-00 (Solaris) 8706 2719 00060 (Volvo) 8350 035654 (Volvo)
59.2710.454		701 x 801 x 200	3	083895B (Plaxton)
51.3731.326		384 x 205 x 116		siehe oben / see above
59.2710.406		701 x 746 x 200	4	284233 (Concorde) AA-01977 (Plaxton)
51.3732.326		384 x 205 x 116		siehe oben / see above
15.3731.470H		368 x 189 x 40	a	284248 (Concorde) 425 562 28 (Iveco) PAA-01976-2 (Plaxton) 150 5201 (Scania) 1905 731 470 (Solaris) 30017741 (VDL) 8706 2719 00030 (Volvo)
15.2711.114		165 x 93 x 25	b	284226 (Concorde) 42545988 (Irisbus) 001 810 60 16 (Mercedes) PAA-01976-3 (Plaxton) 8355 0046556 (Volvo)
15.2712.114		152 x 128 x 23	c	284228 (Concorde) 42545989 (Irisbus) 001 810 61 16 (Mercedes) PAA-01977-4 (Plaxton) 8350 046557 (Volvo)
15.2712.113F		152 x 128 x 23	d	7030 60536 (Volvo)
11.3730.210H		367 x 187 x 60		84434473 (CNH) 425 459 90 * 425 562 27 (Iveco) 150 5202 (Scania) 17294287-7 (Marcopolo) 8706 2719 00052 (Volvo) 1905 770 210 (Solaris)
20.2700.200H		126 x 25 Ø		1299452 (Hymer)
20.2710.200H*		183 x 181 x 84		17294281 (Marcopolo) AA-01978 * AA-01979 (Plaxton) 7036 0530 * 8350 046433 (Volvo)
20.2710.111H		183 x 145 x 107		09-37986101-8 (Marcopolo) 8706 2719 00020 (Volvo) 8350 046970 (Volvo)
20.2710.121		183 x 145 x 107		09-37986101-8 (Marcopolo) 7032 8290 * 033 1121 (Volvo)
20.2480.213		108 x 50 x 15 [800]		356 810 06 11 (Mercedes) AA-01980 * AA-01981 (Plaxton)
20.2480.216H		108 x 50 x 15 [2000]		284240 (Concorde) 83.63731-6507 (MAN) 53-750610-208091 (Merkavim) 145 1226 (Scania) 1970-018-000 (Solaris) P759001645 (VDL) 7033 1124 * 8350 046971 (Volvo)
20.2480.217H		108 x 50 x 15 [5000]		284242 (Concorde) 425 459 85 (Iveco) 81.63731-6470 (MAN) P107424C-10 (Plaxton) 53-707213-480217 (Merkavim) P759001646 (VDL) 7033 1123 7034 8002 (Volvo) 8706 2719 00018 (Volvo) 8350 046432 (Volvo)

Reisebusse / Coaches:
Avtobus, BMC, Concorde, Dallavia,
EvoBus, Euro Coach, Hymer,
Ikarbus, Irisbus, Marcopolo, MAZ,
LAZ, Plaxton, TEMSA, Tovarna,
VDL, Volvo (7500 DD, 7700, 8700,
City Bus, 9300, 9700, Interregio),
Wrightbus



* für für pour 59.2710.406
2 pieces necessary

UNIVERSAL COACHES

291	II (E1) 021203 IV (E1) 021207			INTEGR.
------------	----------------------------------	--	--	----------------

	Beschreibung description descripção descripziune beschreibung benamning popsis ömrcauwe búreilikk reíraks opis		OE
--	--	--	-----------

CAETANOBUS Cobus 3000
CONCORDE Charisma III
01/2012
08/2012
01/2011
10/2012
2011
10/2010
05/2011
06/2011
10/2011

HESS
MAN Lion's City
PLAXTON Panther
PLAXTON Elite
PLAXTON R9700
RUNIRAN R9700
TEMSA Safari
TEMSA Safir
TEMSA MD 9
VISEON C-Serie
Volvo 9700 / 9900
VDL Futura



1
Spiegel mit HS, WWS
mirror with HS, WWS



2
Spiegel mit HS und Bugspiegel
mirror with HS and front crossview mirror

1	59.2910.001.001		24 V	1196 x 696 x 239	284215 (Concorde) 5053-APA-06Y (TEMSA) 44.17604-0317 (Viseon) 2187 9369 (Volvo)
	59.2910.002.001		24 V	1196 x 696 x 239	284216 (Concorde) 5053-APA-04Y (TEMSA) 44.17604-0318 (Viseon) 2189 4545 (Volvo)
	59.2910.019.001		12 V	1196 x 696 x 239	203722 (Carthago)
	59.2910.020.001		12 V	1196 x 696 x 239	203723 (Carthago)
	59.2910.009.001		24 V	1196 x 969 x 239	AP140857C-1 (Plaxton)
	59.2910.010.001		24 V	1196 x 696 x 239	AP119170C-2 (Plaxton) MD301145Y (TEMSA)
	59.2910.005.001		24 V	1196 x 696 x 239	2202 6968 (Carrus)
	59.2910.006.001		24 V	1196 x 696 x 239	
	59.2910.015.001		24 V	1196 x 696 x 239	22360737 (Volvo)
	59.2910.016.001		24 V	1196 x 696 x 239	22360738 (Volvo)
2	59.2910.003.001		24 V	1196 x 696 x 239	AP119170C-100 (Plaxton) 44.17604-0321 (Viseon) HD301144Y (TEMSA)
	59.2910.004.001		24 V	1196 x 696 x 239	44.17604-0322 (Viseon) 2187 9404 (Volvo)
	59.2910.017.001		24 V	1196 x 696 x 239	158388C (Plaxton)
	59.2910.018.001		24 V	1196 x 696 x 239	158396C (Plaxton)
	59.2910.007.001		24 V	1196 x 696 x 239	
	59.2910.008.001		24 V	1196 x 696 x 239	2202 6977 (Volvo)
3	59.2910.013.001		24 V	1196 x 696 x 239	248268 (Concorde)
4	59.2910.014.001		24 V	1196 x 696 x 239	248269 (Concorde)



3
Spiegel mit HS, WWS und ZS (links)
mirror with HS, WWS and ZS (left)



4
Spiegel mit HS, WWS und NBS (rechts)
mirror with HS, WWS and NBS (right)

UNIVERSAL COACHES

291		II (E1) 021203 IV (E1) 021207			INTEGR.
		Beschreibung description description description description benámení propis ovni caunve leirais opis			
61.2910.001.001		262 x 150			3
61.2910.002.001		262 x 150	22117455 (Volvo)		
61.2910.003.001		312 x 150	5053-APA-05Y (Temsal)		4
61.2910.004.001		312 x 150	5053-APA-03Y (Temsal)		
61.2910.007.001	(with LED)	312 x 150	22117457 (Volvo)		5
61.2910.008.001	(with LED)	312 x 150	21885965 (Volvo)		
61.2910.005.001		412 x 150	HD 301152 (Temsal)		5
61.2910.006.001		412 x 150	HD 301151 (Temsal)		
61.2910.021.001		412 x 150	284217 (Concorde)		5
61.2910.022.001		412 x 150	284218 (Concorde)		
09.2910.007.000		1050 x 6 ø			5
09.2910.004.099		2750 x 6 ø	201931 (Carthago)		
09.2910.005.099		3550 x 6 ø	2218519 (Bürstner) 200070749 (Eura Mobil)		5
09.2910.002.099		6050 x 6 ø	2218516 (Bürstner) 284221 (Concorde) 200070751 (Eura Mobil) 44.15240-0300 (Viseon) 2203 8103 (Volvo)		
09.2910.003.099	(for LED or)	6050 x 6 ø	22212554 (Volvo)		5
09.2770.001.000		6050 x 6 ø			
08.3200.233H		42 x 42 x 54	20925244 (Volvo)		5

15.2780.840		307 x 177 x 22	81.63733-0113 (MAN) P119170C-8 (Plaxton) 5053-APA-04-01Y (TEMSEA) 30017846 (VDL) 48.17600-0026 (Viseon)
15.2780.841F		307 x 177 x 22	201932 (Carthago)
19.2910.001.099		184 x 154 x 31	P119170C-7 (Plaxton) 5053-APA-04-03Y (TEMSEA)
19.2910.002.099		184 x 172 x 39	HD301144-02Y (TEMSEA)
08.3950.001.099	Control Unit for	40 x 30 x 30	22038110 (Volvo)
08.2910.001.002	LED		22488075 (Volvo)
61.5590.001.099	for 3 and 4	256 x 165 x 82	
11.2910.001.000	für pour back	597 x 105 x 66	
11.2910.002.000	für pour back	617 x 112 x 105	
11.2910.003.000	für pour front	651 x 112 x 146	
11.2910.004.000	für pour front	509 x 112 x 123	
11.2910.006.000	für pour back	597 x 105 x 66	
11.2910.007.000	für pour back	617 x 112 x 105	
11.2910.008.000	für pour front	651 x 112 x 146	
11.2910.009.000	für pour front	509 x 112 x 123	
11.2910.011.002	für pour	514 x 225 x 121	
11.2910.012.002	für pour	514 x 225 x 121	

CAETANOBUS Cobus 3000 01/2012
CONCORDE Charisma III 08/2012
HESS 10/2011
MAN Lion's City 10/2012
PLAXTON Panther 2011
PLAXTON Elite 10/2010
RUNIRAN R9700 05/2011
TEMSEA Safari 06/2011
TEMSEA Safir 10/2011
TEMSEA MD 9 10/2011
VISEON C-Serie
Volvo 9700 / 9900
VDL Futura

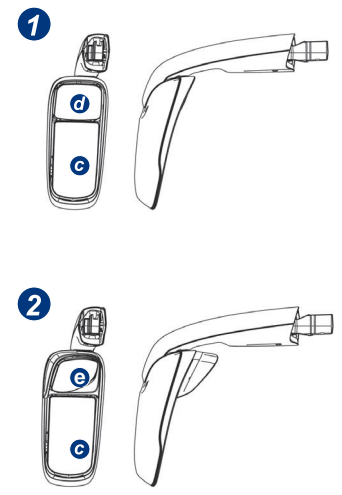
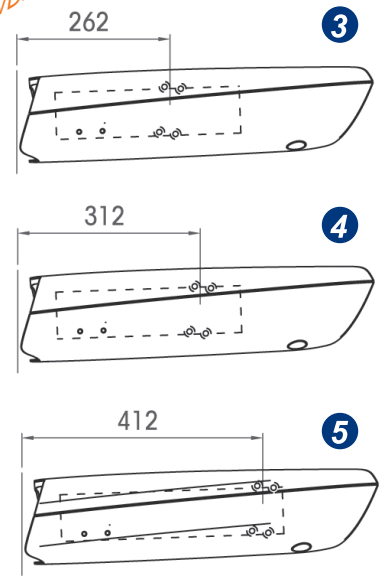

UNIVERSAL

Heizkabel mit Steckanschluss
Heating cable with plug



Steuerkabel
control cable

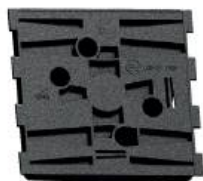

UNIVERSAL ELECTRONICS

MEKRA LANG Group		Beschreibung description description description description benämning popis omicaawe özelliik leirats opis	mm	OE
09.2070.101H			2070 x 9ø	
09.2000.301H			2000 x 9ø	

MEKRA LANG Group		Beschreibung description description description description benämning popis omicaawe özelliik leirats opis	mm	OE
09.3200.320H			2000 x 6ø	
09.3300.421			2000 x 6ø	









MEKRA LANG Group		Beschreibung description description description description benämning popis omicaawe özelliik leirats opis	mm	OE
08.3200.233H			42 x 42 x 54	

MEKRA LANG Group		Beschreibung description description description description benämning popis omicaawe özelliik leirats opis	mm	OE
09.3200.420H			42 x 42 x 54 [2000]	
08.3200.233H			42 x 42 x 54	
09.3200.220			1000	
09.3200.320H			2000 x 6ø	
09.3400.420			42 x 42 x 54 [2000]	
08.3200.233H			42 x 42 x 54	
09.3200.220			1000	
09.3200.320H			2000	
09.3300.421			2000	

MEKRA LANG Group		Beschreibung description description description description benämning popis omicaawe özelliik leirats opis	mm	OE
08.5752.024.099			130 x 94 x 53	
08.1024.124.099			130 x 120 x 45	
08.5752.024.099			130 x 94 x 53	
08.1024.124.099			130 x 120 x 45	

UNIVERSAL ACCESSORIES



248/2 A

		Beschreibung description description description description benámening popis описанье özellik leirás opis	 mm	
20.2480.210H			108 x 50 x 15	5571298 (Bomag) D067504 (Bredamenarini) 218 142 (Fritzmeier) 84433427 (Case New Holland) 7621216 (Liebherr) 17294377-6 (Marcopolo) 671 811 0111 (Mercedes) P105367C-15 (Plaxton) 144 8217 (Scania) 7035 2646 (Volvo) 8706 2719 00055 (Volvo)
20.2480.211H			108 x 50 x 15 [2500]	145 1227 (Scania) 1990-685-650 (Solaris) 2085 4088 (Volvo) 8350 003620 (Volvo)
20.2480.223			108 x 50 x 15 [150]	81.63731-6478 (MAN) 17294378-2 (Marcopolo) 2051 5454 (Volvo) 8706 2719 00040 (Volvo)
20.2480.213			108 x 50 x 15 [800]	356 810 06 11 (Mercedes) AA-01980 / AA-01981 (Plaxton)
20.2480.216H			108 x 50 x 15 [2000]	284240 (Concorde) VI-10-01-010 (Eura Mobil) R21640 (Lahden) 83.63731-6507 (MAN) 53-750610-208091 (Merkavim) 145 1226 (Scania) 1970-018-000 (Solaris) P759001645 (VDL) 7033 1124 / 8350 046971 (Volvo) 284242 (Concorde) 425 45985 (Iveco) 77037873 (Komatsu)
20.2480.217H			108 x 50 x 15 [5000]	R21645 (Lahden) 81.63731-6470 (MAN) 53-7072 13-480217 (Merkavim) P107424C-10 (Plaxton) P759001646 (VDL) 7033 1123 / 7034 8002 (Volvo) 8350 046432 / 8706 2719 00018 (Volvo)

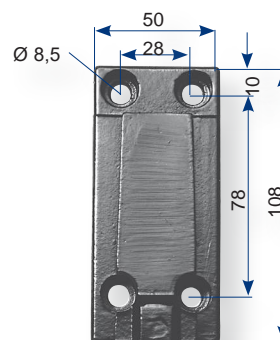
Aufsteckkeile
Mounting wedges



271 A

		Beschreibung description description description description benámening popis описанье özellik leirás opis	 mm	
20.2710.620			124 x 59 x 21 [500]	200083489 (Eura Mobil) 50.00.021.163 (Irisbus) 17042340N0000 (Krauss-Maffei) 53-7072 13-710620 (Merkavim) 7033 1941 (Volvo)

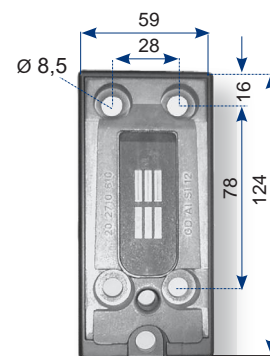

UNIVERSAL

UNIVERSAL AGRICULTURE

Haltestangen brackets

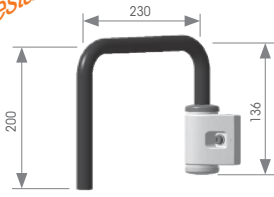

U-Form
U-shape

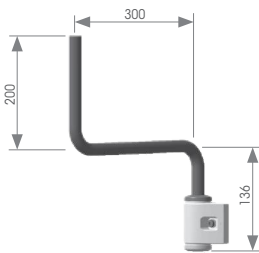

Z-Form
Z-shape

1016



Ø 22 mm



Beschreibung
description
descripção
descriptione
benämning
pops
omicaue
üzeylik
opis



U	58.1016.001.099		200 x 230 x 136
	58.1016.002.099		200 x 230 x 136
	58.1016.003.099		200 x 230 x 136
	58.1016.004.099		200 x 230 x 136
Z	58.1016.005.099		336 x 300
	58.1016.006.099		336 x 300
20.1016.004.000		Sechskant hex attachment for	

Manuell verstellbar in 30°-Stufen

Manually adjustable in steps of 30°

Montage von Innenseite Fahrzeug verschraubt (Variante 2) oder von außen mittels Sechskant verschweißt (Variante 1) möglich

Mounting base bolted through hex attachment (Version 1) or directly bolted from vehicle side (Version 2)

Sowohl hängend als auch stehend montierbar (Darstellung: stehend)

Tube can be turned upside down hanging and standing (Shown: standing)

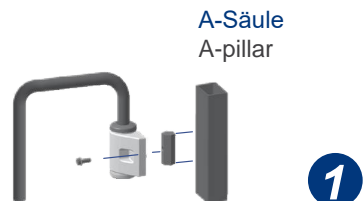
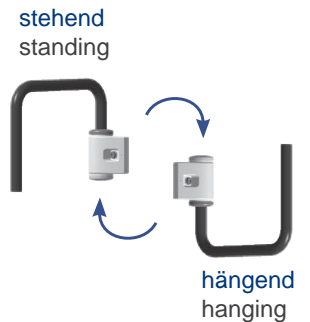

Montage von Außenseite Fahrzeug verschweißt
Mounting base bolted through hex attachment

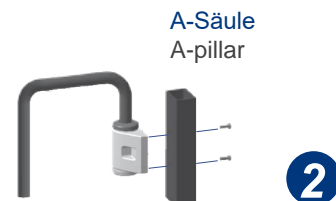

Montage von Innenseite Fahrzeug verschraubt
Mounting directly bolted from vehicle side

UNIVERSAL BUSES

270 A		st		Ø 28 mm	
MEKRA LANG Group		mm		OE	
Beschreibung description description description benamining pops описание leirás opis					
58.2704.051H		90°	270 x 464 x 28 ø	0783032 (Dethleffs) 1905-509-025 (Solaris)	1
58.2704.048		90°	216 x 514 x 28 ø	HEO 627 810 M1 47 (EvoBus) 3600100512654 (Evobus) 1905-508-000 (Solaris) 0000-217-083 (Solaris) 7032 8298 (Volvo) 7033 1060 (Volvo) 2053 5857 (Volvo)	2
58.2704.044		90°	216 x 514 x 28 ø		
58.2704.088		120°	216 x 514 x 28 ø	50.06.232.165 (Irisbus)	
58.2704.070		6°	732 x 327 x 28 ø	1905-509-000 (Solaris) 7032 8294 (Volvo)	3
58.2704.086		6°	732 x 327 x 28 ø	1905 500 010 (Solaris) 2056 4284 (Volvo)	
58.2704.093		6°	732 x 327 x 28 ø	1905-506-010 (Solaris)	
58.2705.003		17°	668 x 350 x 28 ø	7035 2000 (Volvo)	4
58.2705.001H		17°	668 x 350 x 28 ø	7030 9620 (Volvo) 8706 2719 00056 (Volvo) VG10037.000 (Volvo)	
61.2708.842H				150 5203 (Scania)	
61.2703.110		128°	156 x 129 x 36	000 810 04 12 (Mercedes)	
61.2703.120		56°	156 x 129 x 36	000 810 05 12 (Mercedes)	

Haltestangen brackets

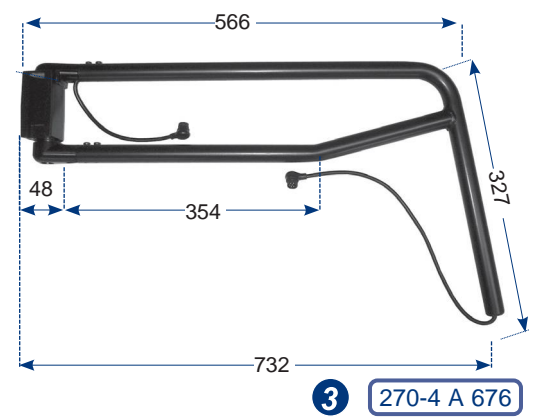
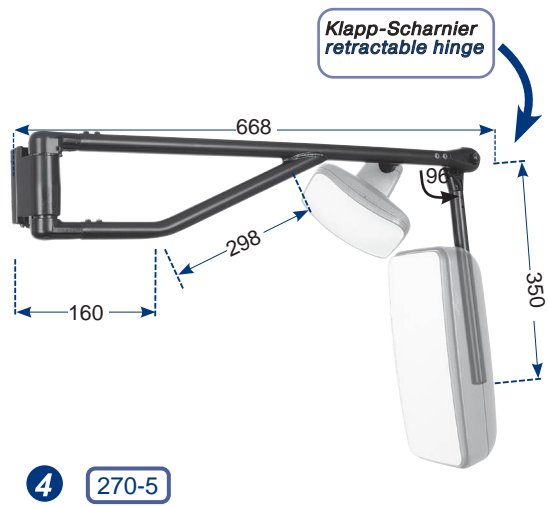
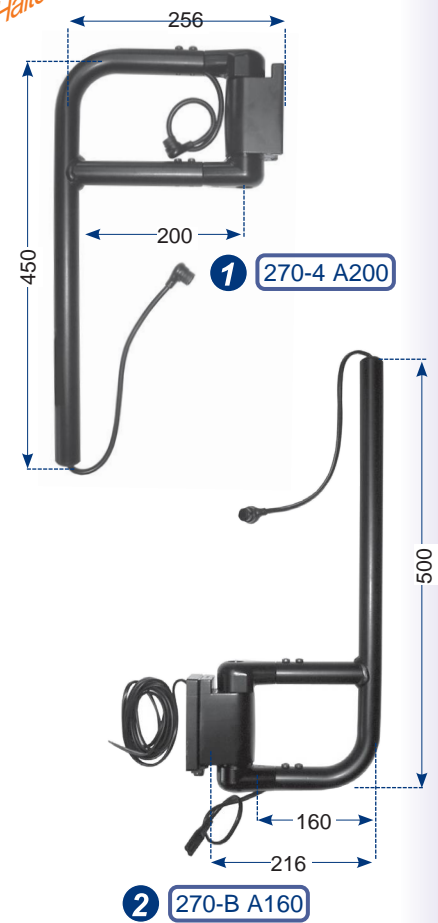

Klappstange
hinged tube

UNIVERSAL

GENERAL TERMS AND CONDITIONS OF SALE AND DELIVERY

I. General Provisions

1. The provisions of the contract between MEKRA Lang GmbH & Co. KG ("MEKRA Lang") and our orderers who are contractors as defined in para. 14 BGB are solely governed by these General Terms and Conditions. Our offers are exclusively meant for entrepreneurs as defined by Article 4 BGB (German Civil Code). Deviating business terms of the customer, even if they are known to us, shall not become a part of the contract. Our offers are always subject to change without notice. Our General Terms and Conditions of Sale and Delivery are considered accepted upon placement of order, at the latest upon receipt of goods. In the case of repeated business relations these General Terms and Conditions of Sale and Delivery also apply for all future transactions. Should individual provisions be or become completely or partially ineffective, then the validity of the other provisions shall thereby not be affected. MEKRA Lang and the customer shall agree upon a regulation the economic success of which shall be as close as possible to the ineffective one. Until such agreement the laws, administrative practice and judicature effective at the time of execution are to be applied.

II. Conclusion of Contract and Prices

1. By ordering merchandise the customer bindingly declares that he wants to buy the merchandise ordered. He shall be bound to this statement for two weeks. We are entitled to accept the offer of a contract underlying the order within two weeks upon receipt of the latter by us. The acceptance may be declared in writing, electronically, or by delivery of the goods to the customer.

2. The obligations in electronic commerce according to Section 312e, par. 1 sentence 1, Nos. 1 to 3, and sentence 2 of BGB (German Civil Code) are excluded.

3. The conclusion of the contract takes place subject to the correct and timely delivery by our sub-suppliers to us. This applies only in case we are not responsible for the non-delivery, especially in case of the conclusion of a congruent hedging business transaction with our sub-suppliers. The customer shall be informed about the non-availability of the product without delay, and the equivalent, insofar as already paid, shall be reimbursed immediately.

4. All contractual financial obligations are to be fulfilled solely in EURO.

5. Prices are understood to be net as ex factory or supply depot. Freight, packaging and import costs, customs duties and other additional taxes are payable by the customer.

III. Period of Delivery and Supply Commitment

1. Our written or electronic order confirmation shall be decisive for extent, type, and date of the delivery. Partial shipments shall be permitted.

2. A liability in meeting delivery deadlines determined as binding shall only be accepted under the condition of undisturbed flow of operations and distribution. In particular in cases of acts of God and other disruptive events at our facilities or those of our sub-suppliers or transport contractors, for example operational or traffic disruptions, fire, flooding, labour-, energy-, or traffic shortages, strikes, lockouts, official measures as well as technical or technological situations that considerably aggravate the execution of the contract, release us from liability in punctual delivery or give us the right to stop delivery without obligation for subsequent delivery.

3. If not agreed otherwise, we have the right to deliver earlier than the delivery deadline. Unless otherwise agreed upon, delivery effected by us one up to a maximum of two weeks after the stipulated delivery date shall not be considered as delayed.

4. Delivery deadlines shall be considered met when the goods have left the works or dispatch depot or the customer has received notice by expiration of the deadline of our readiness to deliver. Subsequent alteration of contract shall be cause for a reasonable extension of delivery deadlines.

5. In the case of contracts whose performance consists of several deliveries, non-performance, defective or delayed performance of one delivery remains without influence upon the other deliveries of the contract.

6. Default of payments, handing in of a state meant in lieu of an oath of disclosure in accordance with § 807 ZPO (German Code of Civil Procedure), temporary shortage of liquid funds, or public knowledge of a considerable deterioration of the financial circumstances of the customer shall entitle us at our discretion to demand payment in advance for outstanding deliveries or to stop deliveries immediately and to deny performance of current contracts. At the same time we shall be entitled to make immediately due and payable those accounts receivable from the customer which are not due yet.

IV. Shipment, Passage of Risk

1. Unless otherwise agreed by the Parties, the choice of packaging, shipping routes and method of transportation is subject to our discretion.

2. The risk of accidental loss and accidental deterioration of the merchandise shall pass over to the customer upon handing it over, in case of a mail order purchase upon delivery of the matter to the forwarding agent, the carrier, or another person or institution determined to execute the shipment. If the customer is overdue in accepting, this shall be equal to a handing over of the merchandise.

3. Merchandise out of call orders shall be accepted within 3 months after issuance of the acknowledgement of order, unless otherwise agreed.

4. Insurance against breakage and transportation risks shall only be taken out upon special request and shall be billed.

5. Customs duties and other expenses, also the costs for payment of the necessary papers for import into the country of destination, shall be payable by the customer.

V. Payments, Terms of Payment

1. Invoices shall be payable:

- within 14 days from date of invoice with 2 % cash discount of the accumulated invoice value;
- within 30 days from date of invoice without cash discount of the accumulated invoice value.

2. Cash discount shall only be granted after all payment commitments out of earlier deliveries have been fulfilled and the invoice amount has been punctually paid to us in cash or has been credited to our account by the aforementioned due dates. The drawing of a bill of exchange can thus not lead to the granting of a cash discount. In case of cashless payment, especially when a cheque is submitted, the date of the credit entry shall be decisive. A cash discount cannot be granted in the case of payment or credit

entry under reserve, with limiting conditions or any other restrictions. The customer shall assume all risks of method of payment. Invoices for tools are subject to immediate payment without cash discount.

3. Bills of exchange and checks shall only be accepted on account of payment. Corresponding credit entries are made only under the limiting condition of correct receipt of the complete amount due. We reserve the right to take in external or own acceptances. Costs and discount expenses are payable by the customer. We assume no responsibility for submission and protest. Protest imposed against the customer's own bills of exchange or non-immediate repayment of protested external bills of exchange shall entitle us to return all bills in circulation. At the same time we shall be entitled to make immediately due and payable those accounts receivable from the customer which are not yet due. Antedated checks shall not be accepted.

4. Interest on defaulted payment of 9%-points over the discount rate of the German Central Bank referred to in § 247 BGB (German Civil Law) as well as a liquidated damages of 40,00 Euro shall be charged in the case of missed payment dates. The right of assertion of further damages caused by delayed performance and other claims shall remain reserved.

5. Advance and part payments are not subject to interest payments.

6. The customer shall only be entitled to offset or withhold payment if his counterclaim is undisputed or has been determined legally binding. The customer may execute a right of retention only if his counter claim is based on the same contractual relationship.

7. Customer and invoice numbers are to be given by the customer when invoices are balanced. Delays or incorrect booking resulting from failure to do so shall be payable by the customer.

VI. Retention of Ownership, Factoring

1. The delivered goods shall remain our property until payment of all claims has been received. The customer has the right to resell the proviso goods within the scope of proper and orderly course of business; however, a pledge or transfer by way of security is not permissible. The customer is required to ensure our rights in the case of resale of proviso goods on credit.

2. The accounts receivable by the customer based on the resale of the merchandise subject to reservation shall now already be transferred to us in the amount of the invoice. We hereby agree to accept this transfer. Regardless of the assignment, the customer shall retain the right to collect payment under the condition that he fulfils his responsibilities to us according to the underlying contractual relationship and does not fall into financial decline. Otherwise the customer must provide the information about the assignment necessary for collection upon our demand and notify his debtors of the respective assignment. In this case we reserve the right to collect the accounts receivable by ourselves.

3. A possible finishing or processing of the merchandise sold subject to reservation by the customer shall always take place on our behalf and by order of us, without any obligations resulting for us from this, however. In the case of processing of proviso goods with other goods not belonging to us, we are entitled to the co-owner portion of the resulting product corresponding to the value of the proviso goods in relation to the other processed goods. Insofar as here and in the following the value of the proviso goods is referred to, this value results from our invoice value.

4. Should the customer acquire sole ownership of the new product according to § 947 paragraph 2 BGB, it is agreed upon that the customer grants co-ownership in the proportion of the value of the processed, attached, or mixed proviso goods, and that he protects these free of charge.

5. In the case of resale of the proviso goods together with other goods, regardless of with or without processing, attachment or mixing, the assignment in advance agreed to above shall be valid only to the extent of the value of proviso goods that were resold together with the other goods. We shall be obligated to release on demand the securities entitled as provided above, if the value exceeds secured payments by 20 %.

6. The customer must immediately notify us and provide the material necessary for an intervention in the case of compulsory execution by third parties against the proviso goods or in case of claims assigned in advance. Any costs resulting from such intervention shall be payable by the customer.

7. The customer shall be obligated to adequately insure the merchandise sold subject to reservation against fire and burglary and has to prove such insurance to us on demand.

VII. Warranty

1. The period of limitation for any warranty claim shall be 24 months as from handover of the goods.

2. First of all, we shall remedy a defect or make a substitute delivery at our discretion. In case of failure to rectify defects or to substitute delivery, the customer can demand rescission of the contract or reduction of the payment. In case there is only a minor contract violation, especially if there are only minor defects, the customer shall not have the right of contract cancellation, however.

3. The customer must notify us in writing of any obvious flaws immediately, at the latest within 7 days after receipt of the goods, and must refrain from any eventual working of protested goods. Otherwise claims based on defects are excluded. The timely dispatch shall suffice for the observance of the warranty deadline. The full burden of proof for all claim prerequisites rests with the customer, especially for the defect itself, for the date of the establishment of the defect, and for the timeliness of the complaint about the defect.

4. Defects which could not be ascertained within this time span despite careful inspection are to be reported to us in writing immediately upon discovery. If the customer opts for a withdrawal from the contract because of a legal imperfection or a physical defect after a failed subsequent fulfilment, then he shall not be additionally entitled to a claim for compensation because of the defect.

5. If, after a failed subsequent fulfilment, the customer opts for a compensation of the damage, then the merchandise shall remain with the customer if this can reasonably be considered acceptable. The compensation is restricted to the difference between the purchase price and the value of the defective product. This shall not apply if we caused the contract violation maliciously.

6. Merchandise for which we have effected compensation shall become our property and is to be returned to us against reimbursement of costs.

7. Claims cannot be made for damages that resulted from the customer's culpably

- improper handling or overstressing the purchased item or

- altering the purchased item in a manner not agreed upon or
- not following the instructions of the mounting or operating manual or
- not observing the complaint and delivery responsibility according to points 3 and 4 above or
- further using the purchased item after ascertaining the defect.

Natural wear and tear is excepted from the warranty.

VIII. Liability

1. In case of simply negligent violations of obligations our liability shall be restricted to an average damage predictable for the type of merchandise, typical for such a contract, and immediate. This also applies in case of simply negligent violations of our legal representatives or agents. We shall not be held liable in case of a simply negligent violation of nonessential contract obligations.

2. The liability by virtue of acceptance of a guarantee as well as due to product liability remains unaffected; the same applies in case of bodily harm or health impairment attributable to us or in the event of loss of life of the customer.

3. Compensation claims of the customer because of a defect shall superannuate after one year from the delivery of the merchandise to the customer. This shall not apply if we can be charged with gross negligence as well as in case of bodily harm or health impairment attributable to us or in the event of loss of life of the customer.

4. As a distributor and importer, you play an important part in ensuring the compliance and safety of products in the market. As a distributor and importer of our products, you are required to comply with the applicable legal provisions and obligations regarding market surveillance, should there be any indications of discrepancies (e.g. in the form of complaints regarding non-compliance with ECE R46 or general, safety-related issues). Please adhere to the corresponding reporting requirements in connection with the above-mentioned anomalies. Any reports to us should be comprised of transparent and verifiable information. Please contact your sales team representative.

IX. Returns

Properly ordered and delivered goods shall in principle not be taken back. Returns that have been agreed upon with us shall remain the exception, which additionally require the following pre-requisites to be met:

- The products must have been acquired directly from us or from one of our works depots.
- Flawless and unaltered condition of the goods.
- In principle, return shall only be possible when the articles in question are still in our product range.
- Return shipment must be "free domicile" to our Ergersheim works or to the appropriate works depot with accompanying delivery note date and number. Value reduction for returns:
 - in the first year after delivery date / 10 % of the contract price
 - in the second year after delivery date / 25 % of the contract price
 - between the 3rd & the 5th year after deliv.date / 50 % of the contract price
 - merchandise over five years old - no return possible
 Technical inspection and completion of the credit slip shall be carried out under consideration of eventual value reduction upon receipt of the articles. Freight costs, insofar as any occurred to us for the original shipping, reduce the remaining value.

X. Industrial Property Rights

- The customer is held liable to us for the exemption from industrial protection rights of third parties on articles ordered, indemnifies us against any possible claims of third parties and has to reimburse any damage to us possibly resulting from a violation of this obligation.
- Our designs and design proposals are to be kept confidential and may not be passed on to third parties.
- All drawings, construction plans, and samples which the customer has received, shall remain our intellectual property.

XI. Place of Fulfilment and Jurisdiction, Other Agreements

1. On principle, the product description of the manufacturer is understood to be decisive for the characteristics of the goods. Public statements, sales talks, or advertisements made apart from this do not represent a contractual description of the characteristics of the goods. Samples and specimens serve as approximate illustrative articles in terms of quality, measurements and colour. Legal claims cannot be inferred from this. Technical changes as well as alterations in shape, colour, and/or weight are reserved within reasonable scope.

2. If the customer receives a faulty assembly instruction, we shall only be obliged to furnish a faultless assembly instruction, and this only if the fault of the assembly instruction is in contradiction with a proper assembly.

3. The customer does not receive warranties in the legal sense of the word from us; warranties of the manufacturers, however, shall remain unaffected by this.

4. Place of fulfillment for our deliveries ex works shall be the delivery works, for delivery ex storage the warehouse. Place of fulfillment for all payments shall be Ergersheim / Bavaria, Germany.

5. The exclusive place of jurisdiction for all litigations from this contract shall be Fuerth / Bavaria, Germany. This also applies to lawsuits based on a cheque or bill of exchange.

6. These provisions shall be governed by the Law of the Federal Republic of Germany. The provisions of the UN Purchase Law shall not be applicable. The wording of the German language version of our "General Terms and Conditions of Sale and Delivery" shall solely be decisive for these General Business Terms.

7. The special terms of our products published with the appropriate price lists shall additionally be applicable.

8. The customer itself shall be responsible to examine the suitability of the goods for the intended final usage.

9. German law (BDSG-Federal Data Protection Law) requires us to inform you that all data of our customers are electronically saved.

As of: 06/2024



Team Aftermarket

Günther Engel, Katharina Graf, Sven Gurrath, Sven Felbinger, Yannic Rauner,
Ivonne Häupler, Marco Wiesmann

Standorte Aftermarkt

Locations for the aftermarket



MEKRALang GmbH & Co. KG

Buchheimer Str. 4
91465 Ergersheim
Germany
Hotline +49 9847 989 8757
Tel +49 9847 989-0
bestellungen@mekra.de
www.mekra.de



MEKRA Lang International ČR. spol. s.r.o

Družstevní 185
33008 Zruč
Czech Republic
Tel +42 0 377 824-893
Fax +42 0 377 824-893
mekra@mekra.cz
www.mekra.cz



MEKRA Lang do Brasil Ltda.

Avenida Paraná 2879
Cajuru do Sul - Sorocoba
SP 18105-000
Brazil
Tel +55 15 3235 3420
Fax+55 15 3235 3421
mekra@mekra.com.br
www.mekra.com.br



MEKRA FRANCE SARL

7, rue de la Prévôté
ZA de la Prévôté
78550 HOUDAN
FRANCE
Tel +33 1 30 47 43 85
contact@mekra.fr
www.mekra.fr



MEKRA Lang North America, LLC

101 Tillessen Boulevard
Ridgeway, SC 29 130
U.S.A.
Tel +1 803 337 52 64
Fax +1 803 337 52 65
sales@lang-mekra.com
http://www.lang-mekra.com



MEKRA UK Limited

17 Willowbrook Road
Ham Bridge Trading
Estate BN14 8NA
Worthing,
Great Britain
Tel +44 1903 206106
Fax+44 1903 214395
info@mekra.co.uk



MEKRA Lang Otomotiv Yan Sanayi A.S.

Baskent Organize Sanayi Bölgesi
19. Cad. No: 60
Maliköy Sincan 06909
Ankara
Turkey
Tel +90 312 640 12 16
Fax +90 312 640 12 25
mekratrurkey@mekra-turkey.com
www.mekra-turkey.com

Anbau • mounting • assemblage • montagem • montaggio • montaje
montering • montáž • монтаж • montaj • gyűlékezés • montáz

Verwendung • application • aplicação • applicazione • aplicación
osňokan • použití • применение • Kullanimi • alkalmazás • aplicacja

links / rechts einsetzbar
applicable for left / right hand side
applicable à gauche / à droite
aplicável para esquerda / direita
per applicazione sinistro / destro
aplicable para izquierda / derecha
justerbar vänster / höger
použiteľné pro levou / pravou / levou/pravou stranu
для применения слева / справа
sol ve sağ tarafa kullanilabilen / sol/sağ tarafa kullanilabilen
bal / jobb oldalra felszerelhető
montáz: strana lewa / prawa

Anbau oben / unten
mounting top / bottom
montage haut / bas
montagem superior / inferior
montaggio superiore / inferiore
montaje superior / inferior
Montering upp / ned
montáž nahoru / doľu
монтаж сверху / сзади
montaj üst / alt
felül / alul szerelt
montáz góra / dót

für links / rechts gesteuerte Fahrzeuge
for left / right hand driven vehicles
pour véhicules conduites à gauche / à droite
para veículos conduzidos pela esquerda / direita
per veicoli con guida sinistra / destra
para vehiculos conducidos a la izquierda / a la derecha
föör vänster / högerstyrda fordon
pro levo / pravostranné řízená vozidla
для автомобилей с рулём слева / справа
sol ve sağdan direksiyonlu araçlar için
soldan / sağdan direksiyonlu araçlar için
bal / jobb oldalt vezetett járművekhez
dla ruchu lewo / prawo stronnego

links einsetzbar für rechts gesteuerte Fahrzeuge
applicable left hand side for right hand drive vehicles
applicable à gauche pour véhicules conduites à droite
aplicável para esquerda / veículos conduzidos pela direita
per applicazione sinistro per veicoli con guida destra
aplicable para izquierda / vehiculos conducidos a la derecha
justerbar vänster för högerstyrda fordon
použiteľné pro pravou stranu pro levostranné řízená vozidla
для применения справа, в автомобиле с рулём слева
sağdan direksiyonlu araçlar için sol tarafa kullanilabilen
bal oldalra felszerelhető, jobb oldalon vezetett járművekhez
strona lewa dla ruchu prawostronnego

rechts einsetzbar für links gesteuerte Fahrzeuge
applicable right hand side for left hand drive vehicles
applicable à droite pour véhicules conduites à gauche
aplicável para direita / veículos conduzidos pela esquerda
per applicazione destro per veicoli con guida sinistra
aplicable para derecha / vehiculos conducidos a la izquierda
justerbar höger för vänsterstyrda fordon
použiteľné pro pravou stranu pro levostranné řízená vozidla
для применения справа, в автомобиле с рулём слева
soldan direksiyonlu araçlar için sağ tarafa kullanilabilen
jobb oldalra felszerelhető, bal oldalon vezetett járművekhez
strona prawa dla ruchu lewostronnego

links einsetzbar für links gesteuerte Fahrzeuge
applicable left hand side for left hand drive vehicles
applicable à gauche pour véhicules conduites à gauche
aplicável para esquerda / veículos conduzidos pela esquerda
per applicazione sinistro per veicoli con guida sinistra
aplicable para izquierda / vehiculos conductos a la izquierda
justerbar vänster för vänsterstyrda fordon
použiteľné pro levou stranu pro levostranné řízená vozidla
для применения слева, в автомобиле с рулём слева
soldan direksiyonlu araçlar için sol tarafa kullanilabilen
jobb oldalra felszerelhető, bal oldalon vezetett járművekhez
strona lewa dla ruchu lewostronnego

rechts einsetzbar für rechts gesteuerte Fahrzeuge
applicable right hand side for right hand drive vehicles
applicable à droite pour véhicules conduites à droite
aplicável para direita / veículos conduzidos pela direita
per applicazione destro per veicoli con guida destra
aplicable para derecha / vehiculos conductos a la derecha
justerbar höger för högerstyrda fordon
použiteľné pro pravou stranu pro pravostranné řízená vozidla
для применения справа, в автомобиле с рулём справа
sağdan direksiyonlu araçlar için sağ tarafa kullanilabilen
jobb oldalra felszerelhető, jobb oldalon vezetett járművekhez
strona prawa dla ruchu prawostronnego

Fahrzeugbreite
width of vehicle
largeur de véhicule
largura do veiculo
larghezza del veicolo
anchura del vehículo
fordonsbredd
šířka vozidla
ширина автомобиля
araç genişliği
járműszélesség
szerokość pojazdu

Anbau am Türrahmen
mounting on the door frame
montage cadre portière
montado na porta
montaggio su cornice porta
montaje en el marco de la puerta
montering på dörrkarm
montáž na rám dveří
монтаж на раму двери
araç kapı çerçevesine montaj
ajtkeretre szerelhető
montaż na drzwiach

integrierter Halter
integrated holder
support intégré
suporte de fixação integrado
supporto integrato
soporte integrado
integriert hällare
integrirováná montáž
интегрированный
tűmlelők anyá tutucusu
integrált tartó
zintegrowany uchwyty

Winkelstellung
angularity
angle of fixation
ángulo
angolatura
angularidad
winkel
űhel nastaveni
yrol
açı pozisyonu
szögállás
położenie
kątowe

Material • matériel • materiale • material
материал • materialy • anyag • materiaľ

Spiegelgehäuse: Kunststoff ABS (schwarz / grau)
mirror housing: plastic ABS (black / grey)
boîtier: matière plastique ABS (noir / argenté)
carcaça: plástico ABS (preto / cinza)
carcassa: plastica ABS (nero / grigio)
carcasa: plástico ABE (negro / gris)
spegelhus: plast ABS (svart / grå)
skořepina zrcadla: umělá hmota ABS (černá / šedivá)
корпус зеркала: пластмасса ABS (цвет чёрный / серый)
ayna gövdesi plastik ABS (siyah / gri)
tükörház ABS-ből (fekete / szürke)
obudowa lustra: tworzywo ABS (kolor czarny / szary)

Spiegelgehäuse: Kunststoff ASA, schwarz
mirror housing: plastic ASA, black
boîtier: matière plastique ASA, noir
carcaça: plástico ASA, preto
carcassa: plastica ASA, nero
carcasa: plástico ASA, negro
spegelhus: plast ASA, svart
skořepina zrcadla: umělá hmota ASA, černá
корпус зеркала: пластмасса АСА, цвет чёрный
ayna gövdesi plastik ASA, siyah
tükörház ASA-ből, fekete
obudowa lustra: tworzywo ASA, kolor czarny

Spiegelgehäuse: Kunststoff PP (Polypropylen), schwarz
mirror housing: plastic PP (polypropylene), black
boîtier: matière plastique PP (polypropylène), noir
carcaça: plástico PP (polipropileno), preto
carcassa: plastica PP (polipropilene), nero
carcasa: plástico PP (polipropileno), negro
spegelhus: plast PP (polypropylen), svart
skořepina zrcadla: umělá hmota PP (Polypropylen), černá
корпус зеркала: пластмасса Полипропилен, цвет чёрный
ayna gövdesi plastik PP (Polipropilen), siyah
tükörház PP-ből, fekete
obudowa lustra: tworzywo PP (polipropylen), kolor czarny

Spiegelgehäuse: Kunststoff PC (Polycarbonat) schwarz
mirror housing: plastic PC (Polycarbonat) black
boîtier: matière plastique PC (Polycarbonat) noir
Carcaça: plástico PC (Policarbonato) preto
carcassa: plastica PC (Polycarbonato) nero
carcasa: plástico PC (Polycarbonato) negro
spegelhus: plast PC (Polycarbonat) svart
skořepina zrcadla: umělá hmota PC (Polycarbonat) černá
корпус зеркала: пластмасса Поликарбонат, цвет чёрный
ayna gövdesi plastik polycarbonat siyah
tükörház PP-ből, fekete
obudowa lustra: tworzywo PC (poliwęglan), kolor czarny

Spiegelstange umschäumt mit PU (Polyurethan)
mirror bracket foamed with PU (polyurethan)
le bras du rétroviseur est recouvert de polyuréthane
Braço revestido de espuma sintética PU (Poliuretano)
braccio schiumato con PU (polyuretano)
brazo revestido de espuma sintética PU (Polyuretano)
spegelarm i skumformad PUR (polyuretan)
trubka držáku zpětného zrcadla zalisovaná v Polyurethanu
брус зеркала покрытый ПУ (полиуретаном)
ayna kolu polyüretan kaplı
tükörtartó kar habosított PU-val borítva
ramię lustra wyściętane PU (poliuretano)

verzinktes Stahlblech
galvanized sheet steel
boîtier en tôle zinguée
chapa de aço galvanizada
acciaio zincato
carcasa de chapa de acero galvanizada
galvaniserad plát
pozinkovaný plech
оцинкованная листовая сталь
galvanizált metal plaka
horganyzott acéllemez
blacha ocynkowana

Stahlrohr
steel tube
tube en acier
tubo de aço
tubo in acciaio
tubo de acero
stálrör
ocelová trubka
стальная трубка
çelik boru
acélcső
rura stalowa

Alurol
aluminium tube
tube en aluminium
tubo de aluminio
tubo de alluminio
tubo de aluminio
aluminiumrör
hliníková trubka
alüminium boru
alucső
rura aluminiowa

Zeitraum • space of time • espace de temps • período de tempo
periodo di tempo • espacio de tiempo • period • období
период времени • dőnem • időbeni kiterjesztés • okres czasu

verwendbar ab Baujahr ... des Fahrzeugs (Monat / Jahr)
usable from year of production ... of the vehicle (month / year)
utilisable à partir de l'année ... du véhicule (mois / an)
aplicado a partir da data de produção do veículo (mês / ano)
utilizzabile dall'anno di produzione del veicolo (mese / anno)
utilizable desde el año de fabricación del vehículo (mes / año)
användbar för fordon med produktionsår from (månad / år)
použiteľné od roku výroby vozidla (mesíc / rok)
применять до ... года изготовления (год / месяц)
Aracın üretim yılından sonra kullanilabilir (ay / yıl)
alkalmazható ... évjáratotól (év / hónap)
rok budowy pojazdu od ... (miesiąc / rok)

verwendbar bis Baujahr ... des Fahrzeugs (Monat / Jahr)
usable until year of production ... of the vehicle (month / year)
utilisable jusqu'à l'année ... du véhicule (mois / an)
aplicado até a data de produção do veículo (mês / ano)
utilizzabile fino all'anno di produzione del veicolo (mese / anno)
utilizable hasta el año de fabricación del vehículo (mes / año)
användbar för fordon med produktionsår to (månad / år)
použiteľné do roku výroby vozidla (mesíc / rok)
применять до ... года изготовления (год / месяц)
Aracın üretim yılına kadar kullanilabilir (ay / yıl)
alkalmazható ... évjáratig (év / hónap)
rok budowy pojazdu do ... (miesiąc / rok)

Zeitraum
space of time
espace de temps
período de tempo
periodo di tempo
espacio de tiempo
period
období
период времени
dőnem
időbeni kiterjesztés
okres czasu

Spiegelklassen • mirror classes • classes de rétroviseurs • classes de espelhos
classi di specchio • classes de retrovisores • spegellasser • třídy zrcadel
классы зеркал • ayna sinifları • tükörsztályok • klasy luster

Spiegelklasse I (Innenspiegel)
mirror class I (interior mirror)
rétroviseur classe I (miroir intérieur)
espelho classe I (espelho interior)
specchio classe I (specchio interno)
espejo clase I (espejo interior)
spegelklass I (innerspegel)
zrcadlo třídy I (zrcadlo vnitřní)
зеркало класс I (внутреннее зеркало)
sinif I ayna (açı ayna)
I tükörsztály (belső tükör)
lustra klasy I (wsteczne)

Spiegelklasse II / III (Hauptspiegel)
mirror class II / III (main mirror)
rétroviseur classe II / III (rétroviseur principal)
espelho classe II / III (espelho principal)
specchio classe II / III (retrovisore principale)
espejo clase II / III (espejo principal)
spegelklass II / III (huvudspegel)
zrcadlo třídy II / III (zrcadlo hlavní)
зеркало класс II / III (главное зеркало)
sinif II / III ayna (ana ayna)
II / III tükörsztály (főtükör)
lustra klasy II / III (głównie)

Spiegelklasse IV (Weitwinkelspiegel)
mirror class IV (wide angle mirror)
rétroviseur classe IV (rétroviseur grand angle)
espelho classe IV (espelho auxiliar)
specchio classe IV (coppa grandangolo)
espejo clase IV (espejo de gran ángulo)
spegelklass IV (vidvinkelspegel)
zrcadlo třídy IV (zrcadlo širokouhlé)
зеркало класс IV (широкоугольное зеркало)
sinif IV ayna (geniş görüş aynası)
IV tükörsztály (nagy látószögű tükör)
lustra klasy IV (szerokokątne)

Spiegelklasse V (Rampenspiegel)
mirror class V (roof mirror)
rétroviseur classe V (miroir d'accostage)
espelho classe V (espelho de rampa)
specchio classe V (specchio guardaruota)
espejo clase V (espejo de rampa)
spegelklass V (närskiktspegel)
zrcadlo třídy V (zrcadlo rampové)
зеркало класс V (зеркало для рамы)
sinif V ayna (kapı üstü aynası)
V tükörsztály (rampatükör)
lustra klasy V (rampowe)

Spiegelklasse VI (Frontspiegel)
mirror class VI (front-under mirror)
rétroviseur classe VI (miroir frontal)
espelho classe VI (espelho frontal)
specchio classe VI (guardaruota anteriore)
espejo clase VI (retrovisor para parte frontal del vehículo)
spegelklass VI (frontspiegel)
zrcadlo třídy VI (zrcadlo čelní)
зеркало класс VI (фронтальное зеркало)
sinif VI ayna (ön tapın aynası)
VI tükörsztály (fronttükör)
lustra klasy VI (przednie)

Spiegelsystem Klasse II + IV
(Hauptspiegel + Weitwinkelspiegel)
mirror system class II + IV
(main mirror + wide angle mirror)
système de rétroviseurs classe II + IV
(rétroviseur principal + rétroviseur grand angle)
espelho classe II + IV
(espelho principal + espelho auxiliar)
sistema di specchi classe II + IV
(retrovisore principale + coppa grandangolo)
sistema de retrovisores classe II + IV
(espejo principal + espejo de gran ángulo)
spiegelsystem klass II + IV
(huvudspegel + vidvinkelspegel)
systém zpětných zrcadel třídy II + IV
(zrcadlo hlavní + zrcadlo širokouhlé)
Система зеркал класс II + IV
(главное + широкоугольное зеркало)
sinif II + IV ayna sistemi
(ana ayna + geniş görüş aynası)
tükörszender II és IV osztályok tükörkkel
(fő és nagy látószögű tükörkkel)
system lusterek klasy II + IV
(głównie + szerokokątne)

Spiegelsystem Klasse II + V
(Hauptspiegel + Rampenspiegel)
mirror system class II + V
(main mirror + roof mirror)
système de rétroviseurs classe II + V
(rétroviseur principal + miroir d'accostage)
espelho classe II + V
(espelho principal + espelho de rampa)
sistema di specchi classe II + V
(retrovisore principale + specchio guardaruota)
sistema de retrovisores classe II + V
(espejo principal + espejo de rampa)
spiegelsystem klass II + V
(huvudspegel + närskiktspegel)
systém zpětných zrcadel třídy II + V
(zrcadlo hlavní + zrcadlo rampové)
Система зеркал класс II + V
(главное + зеркало для рамы)
sinif II + V ayna sistemi
(ana ayna + kapı üstü aynası)
tükörszender II és V osztályok tükörkkel
(fő és rampa tükörkkel)
system lusterek klasy II + V
(głównie + rampowe)

EG- / ECE - gerecht
according to EEC-norm
conforme aux normes / CE
conforme normas da CE
a norma CEE
conforme a las normas CE
EG-godkänd
splňuje normy EU
соответствует нормам ECE
ECC normlarına uygundur
EG / ECE -nek megfelelően
zgodne z EC / ECE

Katalogseite
catalogue page
page du catalogue
página do catálogo
pagina catalogo
página catálogo
Katalogsida
strana katalogu
strаница каталога
katalog sayfasi
katalógus oldal
strona w katalogu

MEKRA Lang - passion for excellence.

Contents are subject to change
Last Update: August 2024
www.mekra.de

